

LX Zeus

LX Zeus Mobile, 2.8, 4.3, 5.5, 7.0 and 8.0

User's manual
(Version 3.4.3)



LX navigation



2.8



4.3



5.5

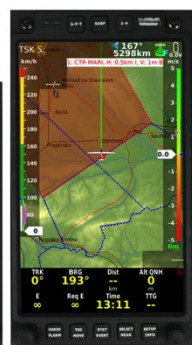

7.0

Zeus



8.0

LX navigation

Tkalska 10
SI 3000 Celje
Tel: 00 386 3 490 46 70
Fax: 00 386 3 490 46 71
www.lxnavigation.si

1	SYSTEM DESCRIPTION	- 7 -
1.1	Screen size options	- 7 -
1.1.1	LX Zeus 2.8	- 7 -
1.1.2	LX Zeus 2.8 Retrofit	- 7 -
1.1.3	LX Zeus 4.3	- 7 -
1.1.4	LX Zeus 5.5	- 8 -
1.1.5	LX Zeus 7.0	- 8 -
1.1.6	LX Zeus 8.0	- 8 -
1.1.7	LX Zeus Mobile	- 8 -
1.1.8	LX Zeus CAI 302	- 8 -
1.2	Hardware concept	- 8 -
1.2.1	USB and SD port	- 9 -
1.2.2	Connections	- 9 -
1.3	Software	- 10 -
1.4	Technical data.....	- 10 -
1.5	Operation and controls	- 11 -
1.5.1	System push buttons (5)	- 11 -
1.5.1.1	VARIO / FLARM button	- 11 -
1.5.1.2	TSK / MOVE button	- 12 -
1.5.1.3	STAT / EVENT button	- 12 -
1.5.1.4	SELECT / NEAR button	- 12 -
1.5.1.5	SETUP / INFO button	- 13 -
1.5.2	Navigation push buttons (3)	- 13 -
1.5.2.1	APT button (Airport, Turn point, Task)	- 13 -
1.5.2.2	SUBP button (Subpage)	- 13 -
1.5.2.3	1-4 button	- 15 -
1.6	Rotary Switches.....	- 16 -
1.6.1	Zoom Rotary switch	- 16 -
1.6.1.1	Additional functions of Zoom	- 16 -
1.6.2	Audio volume rotary switch	- 16 -
1.6.2.1	Additional functions	- 17 -
1.7	Automatic jump out of edit.....	- 17 -
1.8	Display organisation and management	- 17 -
1.8.1	Display organization	- 17 -
1.8.1.1	Indicators	- 17 -
1.8.1.2	Bottom row customization	- 18 -
1.8.1.3	Header customization.....	- 19 -
2	SETUP	- 20 -
2.1	Pilot specific settings.....	- 20 -
2.1.1	Pilot	- 20 -
2.1.1.1	TDT calculation (task delta time).....	- 20 -
2.1.1.2	AAT calculation.....	- 20 -
2.1.2	Audio settings.....	- 21 -
2.1.3	Voice	- 22 -
2.1.4	Vario settings	- 22 -
2.1.5	Indicators.....	- 23 -
2.1.5.1	Secondary indicators	- 24 -
2.1.6	Flarm	- 24 -
2.1.7	Logger - Flight recorder settings	- 25 -
2.1.8	Airspace management	- 25 -
2.1.9	Wind	- 26 -

- 2.1.9.1 Circling method..... - 26 -
- 2.1.9.2 Straight model - 26 -
- 2.1.9.3 Manual wind settings - 27 -
- 2.1.9.4 Influence of wind in final glide - 27 -
- 2.1.10 Graphics (User Interface) - 27 -
 - 2.1.10.1 Map settings - 27 -
 - 2.1.10.2 Fonts..... - 29 -
 - 2.1.10.3 TP/APT settings..... - 29 -
 - 2.1.10.4 Task settings - 30 -
 - 2.1.10.5 Airspaces - 30 -
 - 2.1.10.6 Tail settings - 30 -
 - 2.1.10.7 Track colour - 31 -
 - 2.1.10.8 Track to destination colour - 31 -
 - 2.1.10.9 View SUBP 3 - 31 -
 - 2.1.10.10 Auto close inactivity time out..... - 31 -
 - 2.1.10.11 Statistics colours - 31 -
- 2.1.11 Layout - 32 -
 - 2.1.11.1 Layout edit procedure:..... - 32 -
 - 2.1.11.2 Copy NAVBOXes - 36 -
 - 2.1.11.3 Copy layout..... - 37 -
 - 2.1.11.4 NAVBOX as an indicator - 37 -
- 2.1.12 Brightness adjustment - 37 -

- 2.2 System Setup..... - 38 -**
 - 2.2.1 Units - 38 -
 - 2.2.2 Glider (glider polar selection) - 38 -
 - 2.2.2.1 Speed indicator settings - 38 -
 - 2.2.2.2 Flaps position settings - 38 -
 - 2.2.2.3 TE level and TE filter - 39 -
 - 2.2.3 Checklist..... - 40 -
 - 2.2.4 Notepad..... - 41 -
 - 2.2.5 Transfer - 41 -
 - 2.2.5.1 Transfer of Airport data - 42 -
 - 2.2.5.2 Transfer of Turn Point data - 42 -
 - 2.2.5.3 Transfer of Airspace files..... - 43 -
 - 2.2.5.4 Transfer of Flarm net files - 43 -
 - 2.2.5.5 Transfer Charts..... - 43 -
 - 2.2.5.6 Transfer Checklist..... - 43 -
 - 2.2.5.7 Logbook transfer..... - 43 -
 - 2.2.5.8 Translation files transfer - 43 -
 - 2.2.6 Service - 44 -
 - 2.2.6.1 Screen rotation - 44 -
 - 2.2.6.2 Compass calibration - 44 -
 - 2.2.6.3 AHRS Level adjust (Pitch and Roll)..... - 45 -
 - 2.2.6.4 Disable AHRS..... - 46 -
 - 2.2.6.5 Detected hardware - 46 -
 - 2.2.7 Locale..... - 46 -

- 3 UPDATE PROCEDURE - 46 -**

- 4 NAVIGATION MODES - 47 -**
 - 4.1 APT mode (navigation to airports) - 47 -**
 - 4.2 How to select an airport? - 47 -**
 - 4.2.1 APT selection from NEAR function - 48 -
 - 4.3 Navigation in APT / TP or TSK mode..... - 48 -**
 - 4.3.1 Sort by filter - 48 -
 - 4.3.2 Main graphic navigation page - 48 -
 - 4.3.3 Second navigation page (subpage) - 49 -

- 4.3.4 Third navigation page (2nd subpage)..... - 49 -
- 4.3.5 Use of Remote Stick in APT..... - 50 -
- 4.4 Turn point mode - 50 -**
 - 4.4.1.1 Edit TP..... - 51 -
 - 4.4.1.2 Creation of User Turn points - 51 -
 - 4.4.1.3 Add Marker - 52 -
 - 4.4.1.4 Delete TP..... - 52 -
 - 4.4.1.5 Send TP..... - 52 -
 - 4.4.2 Selection of a Turn Point..... - 52 -
 - 4.4.2.1 Selection from Near..... - 53 -
 - 4.4.3 Navigation to a Turn Point..... - 53 -
 - 4.4.3.1 Use of Remote stick - 53 -
- 4.5 Task Mode - 53 -**
 - 4.5.1 Task organization - 53 -
 - 4.5.1.1 Task declaration - 53 -
 - 4.5.2 Task selection - 53 -
 - 4.5.3 Task creation by “hand” - 54 -
 - 4.5.3.1 Create and Edit Zones - 55 -
 - 4.5.4 Task Start (ARM), Restart, Next TP, Clear, Save, Team Code, Limitations - 56 -
 - 4.5.4.1 Task Start - 56 -
 - 4.5.4.2 Task Restart function..... - 56 -
 - 4.5.4.3 Over Turn point..... - 57 -
 - 4.5.4.4 Saving TSK to USB - 57 -
 - 4.5.4.5 Clear TSK..... - 57 -
 - 4.5.4.6 Team Code..... - 58 -
 - 4.5.4.7 Limitations - 58 -
 - 4.5.5 MOVE Function (during flight)..... - 58 -
 - 4.5.6 Task Zoom - 59 -
 - 4.5.7 Use of Remote Stick - 59 -
- 5 AIRSPACE MANAGEMENT - 60 -**
 - 5.1 Basic airspace settings..... - 60 -**
 - 5.1.1 Hide airspaces above..... - 60 -
 - 5.1.2 Other setups..... - 60 -
 - 5.1.3 Define appearance of airspaces regarding zoom - 60 -
 - 5.1.3.1 Warnings - 60 -
 - 5.1.4 Disabling of airspace sections..... - 61 -
- 6 GPS SIGNAL MANAGEMENT - 62 -**
 - 6.1 Colibri II plug..... - 62 -**
 - 6.2 Flarm plug - 62 -**
 - 6.3 GPS signal for navigation..... - 63 -**
- 7 LX ZEUS AND COLIBRI II - 63 -**
 - 7.1 Colibri II power management - 63 -**
 - 7.2 Colibri II - Zeus interaction - 63 -**
 - 7.2.1 Commands and declaration transfer to Colibri II..... - 63 -
- 8 LX ZEUS AND FLARM - 64 -**
 - 8.1 Flarm external displays..... - 64 -**

- 8.2 Task declaration into Flarm.....- 65 -**
- 8.3 Transferring files from Flarm- 65 -**
- 8.4 Flarm Red Box / Mini Box update- 65 -**
- 8.5 Flarm PIN OUT- 65 -**
- 9 LX ZEUS AND GARRECHT- 66 -**
- 9.1 LX ZEUS and Garrecht TRX-1090 ADSB / TRX-2000.....- 66 -**
- 9.2 LX ZEUS and Garrrect TRX-1500- 66 -**
- 10 REMOTE CONTROL.....- 67 -**
- 10.1 Use of Remote Stick.....- 67 -**
- 10.2 Remote in second seat- 67 -**
- 11 LX JOY- 68 -**
- 11.1 General- 68 -**
- 11.2 Button description.....- 68 -**
- 12 SECOND SEAT UNIT- 71 -**
- 12.1 Connection of Vario and Remote.....- 71 -**
 - 12.1.1 Secondary Vario setup- 71 -
- 12.2 Interaction LX Zeus – LX Zeus Second seat.....- 71 -**
 - 12.2.1 TSK / TP / APT exchange.....- 72 -
 - 12.2.2 Downloading flights from Second seat- 72 -
- 13 FLYING WITH LX ZEUS- 73 -**
- 13.1 Flight preparation on ground- 73 -**
 - 13.1.1 Before take off.....- 73 -
 - 13.1.1.1 Setting of the take-off elevation.....- 73 -
 - 13.1.1.2 QNH setting- 73 -
 - 13.1.1.3.....- 73 -
 - 13.1.1.4 Task declaration process- 74 -
- 13.2 During flight- 74 -**
 - 13.2.1 Set MacCready, Ballast, Bugs and QNH.....- 74 -
 - 13.2.2 Statistics.....- 75 -
 - 13.2.2.1 Thermal Analysis- 75 -
 - 13.2.2.2 OLC Calculation- 76 -
 - 13.2.2.3 Baro trace graph.....- 76 -
 - 13.2.2.4 Task Statistics- 76 -
 - 13.2.2.5 Route- 77 -
 - 13.2.3 Special functions.....- 77 -
 - 13.2.3.1 Event function.....- 77 -
 - 13.2.3.2 Marker setting.....- 77 -
 - 13.2.3.3 Pan mode- 78 -
 - 13.2.4 Task Start.....- 78 -
 - 13.2.4.1 Start Conditions / Limitations.....- 79 -
 - 13.2.4.2 Task Restart- 79 -

13.2.4.3	Restart Leg	- 79 -
13.2.5	Task Finish.....	- 79 -
13.2.6	Flying AAT (Assigned Area Task).....	- 80 -
13.2.7	Final glide calculation	- 81 -
13.2.8	Finish line crossing	- 81 -
13.2.9	Thermal assistant	- 82 -
13.2.10	Flarm management.....	- 82 -
13.2.11	Artificial horizon – AHRS	- 83 -
13.3	After landing	- 84 -
13.3.1	Downloading of flights.....	- 84 -
13.3.1.1	Downloading Colibri II flights	- 85 -
13.3.1.2	Downloading of flights recorded by Zeus	- 85 -
13.3.1.3	Downloading flights stored in Flarm	- 85 -
13.3.1.4	Colibri II – Zeus interaction after landing.....	- 85 -
13.3.2	Recommendations for safe operation.....	- 86 -
13.4	ICAO charts	- 86 -
14	INSTALLATION.....	- 87 -
14.1	Mechanical installation	- 87 -
14.1.1	Installation of Vario unit	- 87 -
14.2	Screen rotation	- 87 -
14.3	Electrical installation.....	- 88 -
14.3.1	Installation of USB D 60 (Vario unit).....	- 88 -
14.3.1.1	USB-D 60 wiring.....	- 89 -
14.4	Installation of second seat units.....	- 90 -
14.4.1	Electrical installation	- 90 -
15	EXPLANATION OF TERMS	- 91 -
16	ZEUS MOBILE	- 92 -
17	FAQ (FREQUENTLY ASKED QUESTIONS)	- 93 -

1 System description

The system consists of a minimum of two units. One of them is a gliding computer the other unit is a 57 mm vario. The vario unit is also available as an 80 mm option. The gliding computer has a sunshine readable and anti-reflective 5.5 inch colour display and a high power Linux running computing device. The vario is a standalone unit and has its electronics based on high precision digital sensors and transducers. The connection between vario and computer unit is via LX system bus. System extensions (second seat unit, remote control, compass) are also possible after connecting the LX system bus solution. All connections are plug and play, which means no specialists are required to install the system.

Note!
Pictures used in this manual may slightly differ from the LX Zeus original screens.



1.1 Screen size options

LX Zeus comes in five different screen size variants, which makes it possible to install the LX Zeus system into practically any instrument panel. The complete electronics and also all functions are the same for all variants. The only difference is, that the 2.8 and 4.3 options use the 2x4 push button organization where as 5.5, 7.0 and 8.0 have a 5x3 push button organization. Every unit except the 2.8 option is delivered with a suitable steel template which makes it possible to prepare a new cut out by hand. There are two orientations possible*: **landscape** or **portrait** orientation. This can be specified during ordering. The user can also change the orientation in the system settings.

*Zeus 2.8 is only available in landscape orientation.

1.1.1 LX Zeus 2.8

This version of Zeus can be installed into any normal 80 mm panel cut out and therefore does not require an instrument panel upgrade. Display orientation is only landscape.

1.1.2 LX Zeus 2.8 Retrofit

Zeus 2.8 Retrofit is the same display size as Zeus 2.8 but differs in hardware. Vario (USB-D) module is inside of the main unit and only a vario indicator is needed. Back plate is equal to LX 5000 (2x 15pin connectors). If LX 5000 has a 25 pin connector, an adapter for 2x15 to 25 pin is needed, which can be supplied from the LX Navigation Company. The purpose of Retrofit solution is that all wiring remains as is, also an old vario indicator can be used!

1.1.3 LX Zeus 4.3

The display diagonal of the system is 4.3-inch and has following outline dimensions:

- 83x136x52 mm

1.1.4 LX Zeus 5.5

This is the most common used variant and comes with 5.5-inch display. Layout size is:

- 106x146x52 mm

1.1.5 LX Zeus 7.0

This version size can be fitted in the majority of instrument panels used in modern gliders. The display size is 7-inch and the unit layout is:

- 110x190x52 mm

1.1.6 LX Zeus 8.0

This is the biggest LX Zeus model and its display diagonal is 8-inch.

- 161x218x52 mm

1.1.7 LX Zeus Mobile

LX Zeus Mobile is a derivate from LX Zeus 4.3. The unit uses a 4.3-inch display, the same as by Zeus 4.3. The unit is prepared to be installed as an integral part of the panel, but can be also used as a mobile device installed on panel by using a gooseneck. A vario unit is also a part of delivery and its default configuration is a black box solution. An upgrade to color display and the needle is possible at any time.

1.1.8 LX Zeus CAI 302

All Zeus units can be connected to Cambridge vario CAI 302 as a plug and play solution. Cambridge vario must be connected to Zeus Flarm port, so in case of CAI configuration Flarm cannot be connected to LX Zeus. Zeus is exchanging following data with CAI:

- QNH
- Vario data
- Airspeed
- GPS
- MC
- Volume

CAI 302 vario is powered from LX Zeus device.

1.2 Hardware concept

The system is designed to offer flexible solutions of system configurations, so the pilot is able to provide some kind of custom design. At the back side of the unit there are plenty of connectors which make it possible to connect (plug and play) a various palette of GPS signal sources, as the unit does not have integral an GPS receiver. Units as Colibri, LX 20, VL and any other GPS source which is capable of delivering NMEA data at nearly any baud rate, are compatible.

A special plug is provided for **Colibri II** connection and in that case Colibri II is also powered from Zeus. Using of Colibri II offers some important benefits for the pilot. The benefits are:

- automatic switch on of Colibri II as Zeus is powered on.
- automatic power off after Zeus will be switched off and the system is no longer in flying mode; if flight status is detected, Colibri II will continue logging its own internal battery.
- downloading of flights via Zeus USB stick

When two GPS sources are connected at the same time, both signals are combined and losing one of the GPS sources will not degrade system availability. Colibri II is used as an IGC flight recorder in the case of an IGC approved solution. In that case a high level of communication is established between Colibri II and Zeus and the pilot is able to operate the system in the same way as by an integral flight recorder. The Colibri II unit can operate in **portrait** and in **landscape** orientation. Changing orientation is very easy and can be done by pilot. See Colibri II user manual for more information.

Commercially available versions:

- **LX Zeus IGC:** package consists of LX Zeus Computer, Colibri II high level approved flight recorder with ENL, OAT sensor, USB key, main power cable with switch, USB D 60 vario unit and USB D cables
- **LX Zeus Flarm:** LX Zeus Computer, Flarm which is not IGC (optionally can be IGC), Flarm dipole antenna, SD card for Flarm, Flarm cable to Zeus, Flarm SD cable to Zeus, Flarm GPS antenna, OAT sensor, USB key, main power cable with switch, USB D 60 vario unit and USB D cables
- **LX Zeus Flarm IGC:** LX Zeus Computer, Flarm which is not IGC (optionally can be IGC), Flarm dipole antenna, SD card for Flarm, Flarm cable to Zeus, Flarm SD cable to Zeus, Flarm GPS antenna, Colibri II high level approved flight recorder with ENL, OAT sensor, USB key, main power cable with switch, USB D 60 vario unit and USB D cables
- **LX Zeus:** LX Zeus Computer, USB key, main power cable with switch, USB D 60 vario unit and USB D cables

Rotary switches and push buttons

There are **8 push** buttons and **two rotary** switches on the front of the unit. Also the rotary switches have a double push function (short and long press). On one side there are five push buttons which all have a double push function (short and long press) and on the other side there are three push buttons with one push function. Buttons are labelled and this makes unit manipulation very easy. (Zeus 2.8 has a 4x4 push button organization.)



Both rotary switches are multifunctional as follows:

Default functions:

- audio volume adjustment function
- zoom selector

In edit:

- zoom: scrolling and press confirmation
- volume: bigger steps of scrolling and escape/cancel by pressing



1.2.1 USB and SD port

An A-size USB port is situated on the front panel. The port is exclusively used for data transfer and firmware updates. The customer can also easily update the firmware. The SD port is only used when a Flarm is connected (Flarm Red Box, Swiss Flarm and optionally Flarm Mini Box). The SD port makes direct communication with Flarm possible, which means downloading of flights stored in Flarm, uploading of declaration and also Flarm updating.

1.2.2 Connections

On the back side of the unit there are following connectors:

- 4x 485 system bus (Zeus 2.8 has 2x 485)*
- 2x CAN bus**
- Colibri II port (5V and data)***
- Flarm port (12 V power and data)****
- 2x Flarm display outputs
- 1x Flarm SD
- 1x OAT plug to connect OAT sensor

Zeus 5.5/7.0 with AHRS:

- 1x Pst connector
- 1x Ptot connector
- 1x USB (not in use)



* 485 connects LX Zeus to:

- USB D 60 Vario unit
- Remote control stick
- Secondary Vario indicators
- Compass module
- Voice module

** CAN bus:

- Connects Second seat unit

*** Colibri II port:

- Makes possible to arrange direct connection of LX Zeus to Colibri II only via cable (special cable required, is included when purchased together)

**** Flarm port can be also used to connect any other GPS source which has an IGC standard connector. For instance: Colibri LX 20, VL... If Flarm is connected, two Flarm displays can be connected to the system by using Display 1 and Display 2 plugs. The SD connector is directly connected to the micro-SD card reader on the front of the Zeus.

1.3 Software

SW package is completely developed by LX Navigation and is running on Linux operation system. The logic used kept the well-known LX Navigation philosophy, but some new approaches have been involved. The SW is continuously developed and upgrades are regularly published. Upgrades of SW can easily be done by user without requiring any passwords. Contact your dealer to get notified of future updates.

1.4 Technical data

Computer module 4.3, 5.5, 7.0, 8.0:

- 4.3, 5.5, 7.0 or 8.0 inch sunshine readable anti-glare display
- Landscape or portrait orientation
- Power requirements: typically 400 mA at 12 V (may vary due to backlight intensity settings)
- 8 push buttons
- 2 rotary switches with push functions
- USB size A port
- SD card reader (for Flarm only)

Computer module Zeus 2.8:

- 2.8 inch sunshine readable antiglare display
- Power requirements: typically 300 mA at 12 V
- Layout: 80 mm size, landscape only orientation
- 8 push buttons
- 2 rotary switches with push functions
- USB size A port
- SD card reader (for Flarm only)

Vario module (USB D 60):

- 57 mm air norm (60x60 mm)
- Optionally 80 mm
- Mechanical needle with colour display
- Power consumption: 120 mA at 12
- 485 bus compatible unit



1.5 Operation and controls

8 push buttons and two rotary switches are used to control the Zeus. LX Navigation Remote Stick or LX joy can also be used to control the unit.

Push buttons are divided into two groups. Group of 5 buttons situated between the two rotary switches are meant for system inputs. All five buttons support two functions; long or short press. Short press activates the top labelled function and long press (approximately 2 seconds) activates secondary function, which is labelled below the top one. Next three push buttons are used during navigation to switch between navigation modes. These buttons do not support long press functions.

1.5.1 System push buttons (5)

- Vario / Flarm
- TSK / Move
- Stat / Event
- Select / Near
- Setup / Info

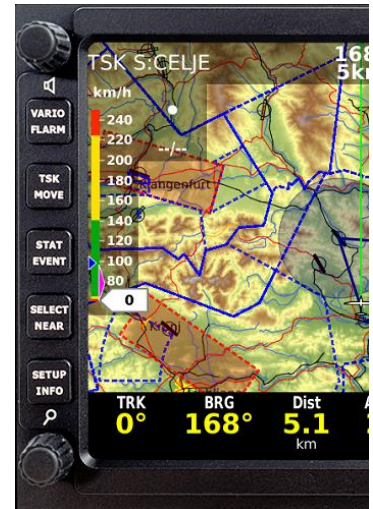

1.5.1.1 VARIO / FLARM button

- VARIO (short press): input of MC, Ballast, Bugs and QNH
- FLARM (long press): activation of Flarm radar screen

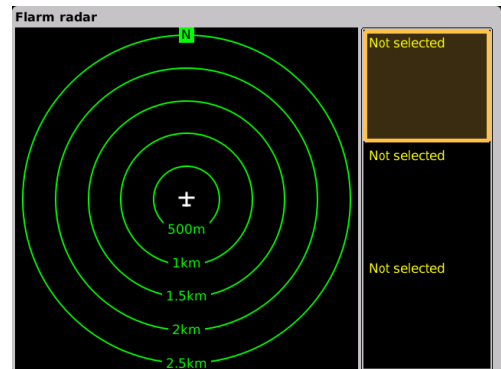
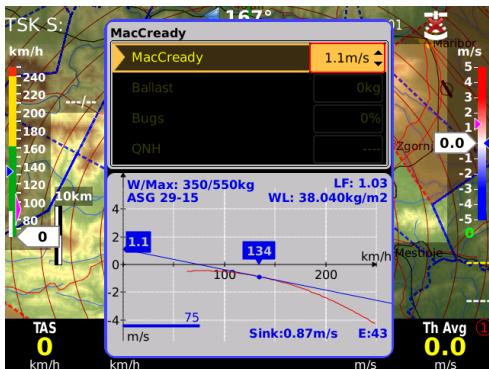

1.5.1.1.1 Explanation of VARIO screen

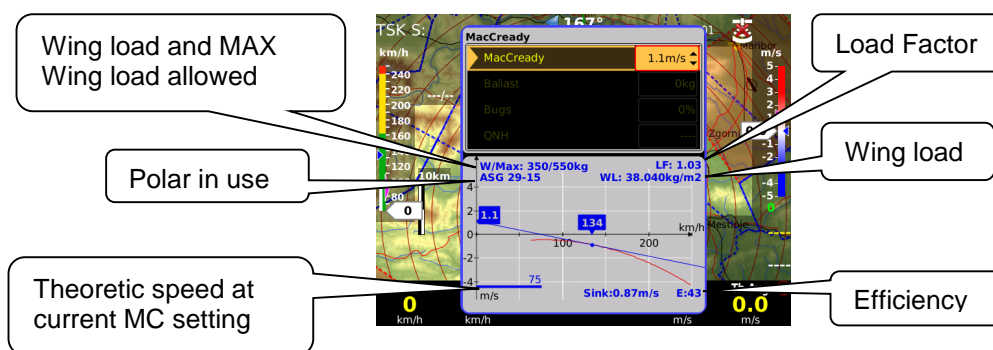

1.5.1.2 TSK / MOVE button

- TSK: task management, for next actions use press buttons near to the labels
- MOVE: executing of move function by AAT

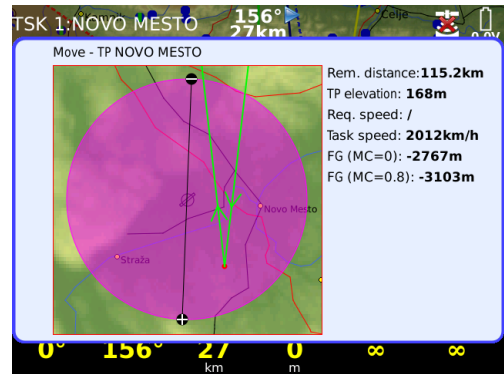
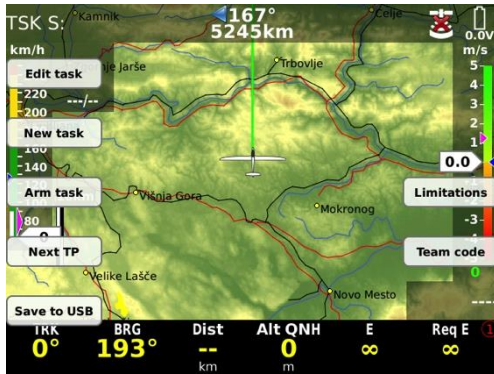

1.5.1.3 STAT / EVENT button

- STATISTICS: flight and task statistics
- EVENT: activation of Event function in Colibri II

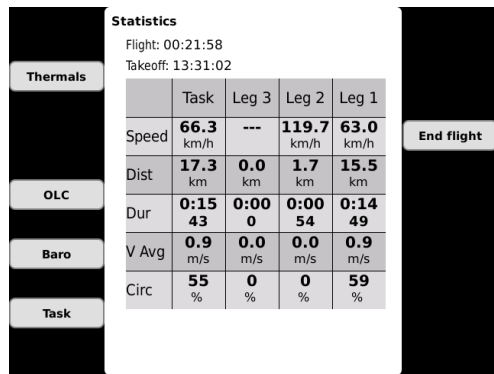

1.5.1.4 SELECT / NEAR button

- SELECT: selection of APT, TP, TSK, Airspace and activation of Pan mode (see flying)
- NEAR: activation of near function (Landing points / Markers, Turnpoints, Airspaces...)



1.5.1.5 SETUP / INFO button

- SETUP: direct access to Setup menu
- INFO: information about GPS source, and other data, system configuration (latest software version), selected pilot with all data, glider configuration and sunrise/sunset time. Here you can find also a message about disabled AHRS.

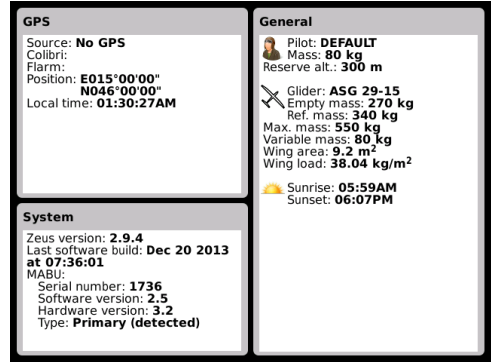
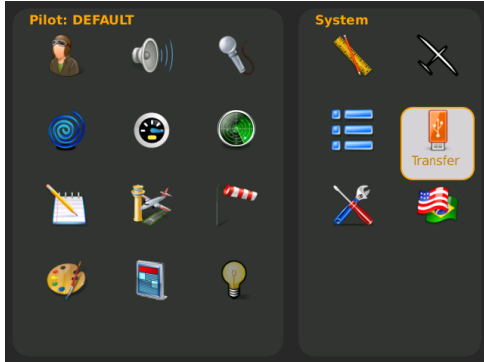

1.5.2 Navigation push buttons (3)

Three buttons are used to leaf through the navigation menus of LX Zeus.

- APT
- SUBP
- 1-4



1.5.2.1 APT button (Airport, Turn point, Task)

After each press the next mode will be selected. This will only change the main page.

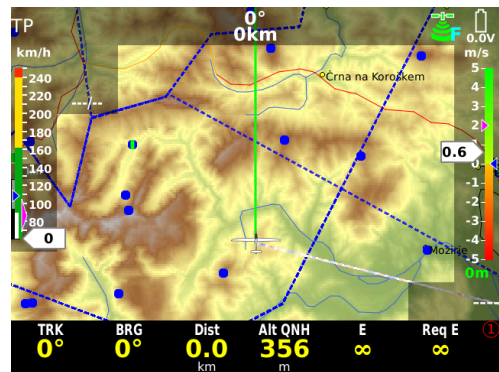

1.5.2.2 SUBP button (Subpage)

SUBP (subpage): after every push, subpage of APT, TP or TSK screen will open. The procedure is circular.

- 1st subpage is divided into two parts. The upper part consists of vertical terrain profile and lower part consists of Airport / TP data and TSK statistics.

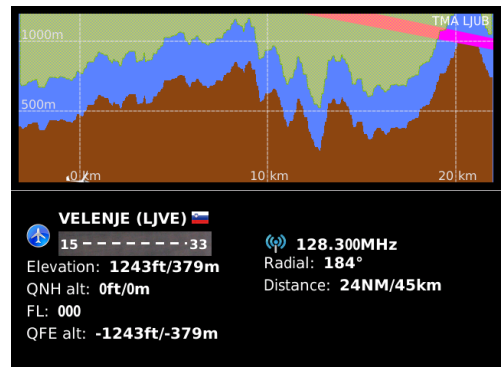

- 2nd subpage is divided into map and 3D terrain display or Artificial horizon (AHRs), if it is the part of the system.

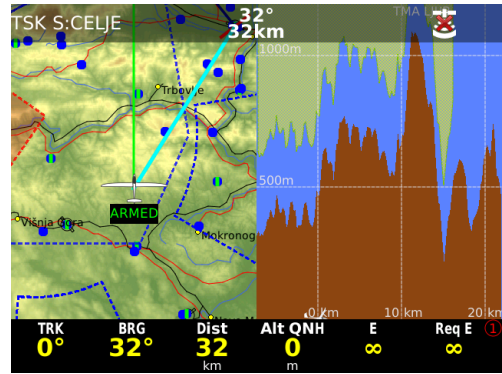

1.5.2.2.1 First navigation subpage

First navigation subpage is available after press on SUBP button and this is valid for all three navigation modes. The page is divided into two sections. Upper section is reserved for vertical terrain profile, the lower part shows APT and TP data / circling log/ wind at different altitudes. Subpage at TSK shows task's statistics by legs / circling log / wind at different altitudes. Switching between lower info can be done after press on 1-4 button.

Vertical terrain profile shows glider position regarding to the terrain and the airspace. Final glide profile for MC 0 and actual MC is also visualized as a cone.

The terrain is shown in all 3 pages (TP, APT, TSK). The profile of the terrain is chosen according to the terrain from current position to selected TP, APT and through all TPs on the TSK. The terrain mode also shows the airspaces in a vertical profile with different colours. With Zoom knob you can **adjust the scale**.

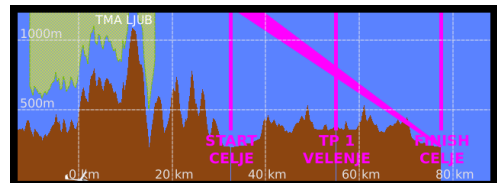
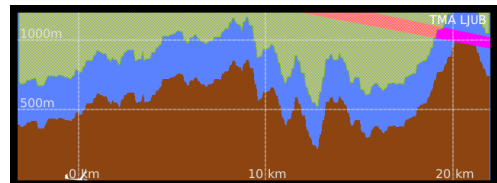

	Task	Leg 2	Leg 1			
Speed	---					
Dist	0.0 km					
Dur	0:00:00					
V Avg	0.0 m/s					
Circ	0%					

1.5.2.2.2 Second navigation subpage

This page shows 3D terrain data regarding to glider present position. If the artificial horizon is integrated in the Zeus, then the second navigation page will be an artificial horizon (AHRs).

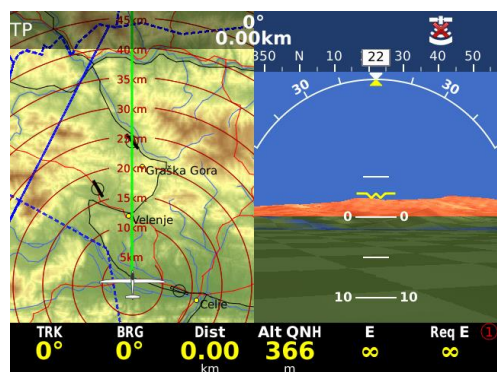

1.5.2.3 1-4 button

LX Zeus uses the bottom row for NAV BOX presentation. Infinite variants are fully programmable and selectable by the 1-4 push button.

The colours, transparency and presentation of the bottom NAV BOX container is a matter of custom design. See more in **Setup Layout**.

Actual bottom row variant is shown by a number (1-4) which is located in the right lower corner of ZEUS screen.

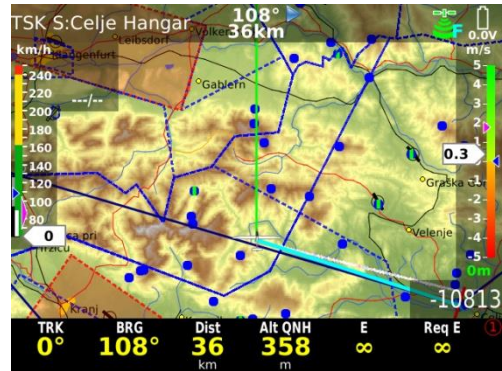

1.5.2.3.1 Custom creation of bottom rows (NAV BOX row)

Any NAV BOX position can be custom designed. The procedure starts after a **long press** on Zoom button. A yellow marked window shows ready status.

Rotate Zoom to find position for your NAV BOX and press Zoom. A list of possible NAV BOX information will open. Rotate Zoom to find NAV BOX of interest and confirm it with press on Zeus.

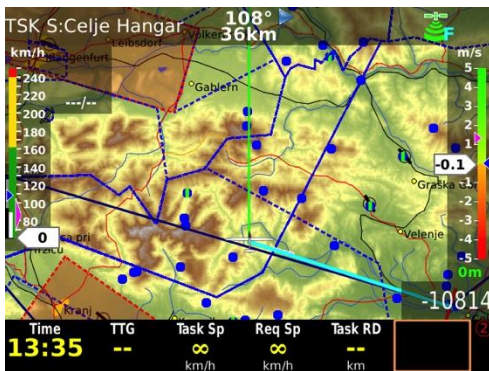
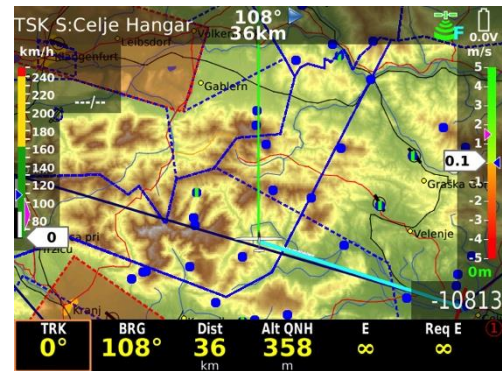

Note!
To select next bottom row which is still empty simply press on 1-4 button.

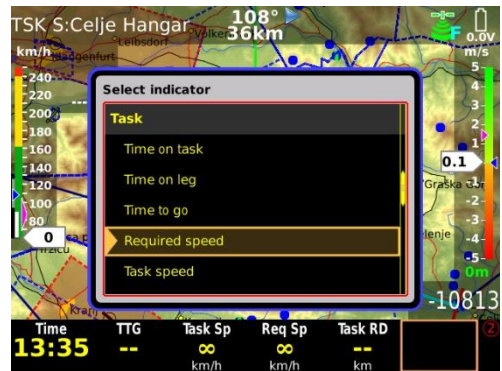

Note!
Editing of bottom row is also possible during flight.

1.5.2.3.2 Bottom row layout

Bottom row can be positioned on the bottom of the display and as well on the top (in fact any position can be chosen). The info row can be used as single row, double or triple row. For more information see **Setup/Layout**.

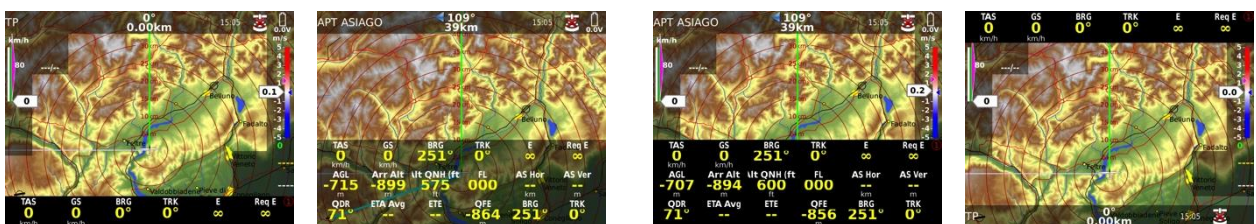

Examples of bottom row layouts

1.6 Rotary Switches

Both rotary switches are multifunctional; their basic functions are audio volume adjustment and zoom adjustment. The push function on the rotary switches also offers significant help connected with editing and selection.

1.6.1 Zoom Rotary switch

Its direct function is the selection of zoom factor (scale of the map) in graphic page. After every change a new scale factor will be selected and the actual scale is shown as 1: xxxxxx and not in kilometres or Nm (as it was in older LX Navigation units).

1.6.1.1 Additional functions of Zoom

After press has been activated the function of Zoom rotary switch will change and the switch will become the most common used switch for LX Zeus operation during editing and selection processes. Any input and also scrolling can be done after using of Zoom switch.

Note!

Press on Zoom should be used after any attempt to make inputs. After press immediate inputs are possible when rotating the knob.

Example 1: update of MC

- press **Vario** button
- select item (MC, Bal..) by Zoom knob (rotate)
- **press** on Zoom knob
- adjust new value, **rotating** Zoom or Volume
- **press** on Zoom to confirm it
- **press** on Volume knob to escape

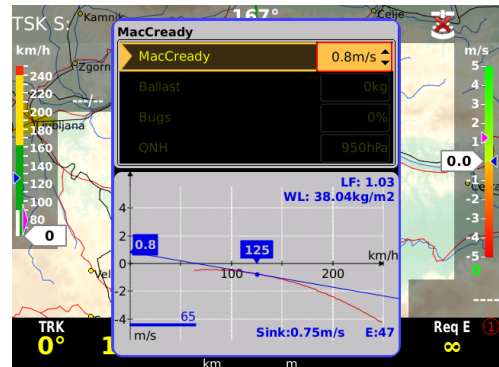

1.6.2 Audio volume rotary switch

The volume adjustment can be done for vario (in vario mode) and for SC (in SC mode)

A bar will show audio volume status after rotation.

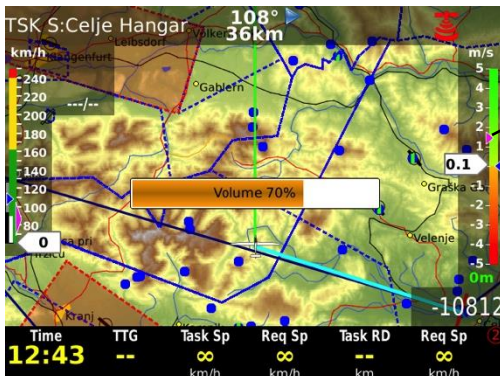

1.6.2.1 Additional functions

The main secondary function of volume rotary switch is its press function. When pressed in edit mode will execute jump out of the menu. The push function isn't active in navigation menus (APT, TP and TSK). After activation all already done edit inputs will remain, so the button is not a cancel button. By pressing the volume button in TP, APT in TSK menu, the shortcut to select the TP, APT or TSK will open. Scrolling audio switch will increase volume by 5%. During input of numbers and letters, rotating will delete wrong input character and move cursor one position back.

1.7 Automatic jump out of edit

If you get lost in edit, simply don't touch any command for approximately 15 seconds and the unit will change back to the last selected menu. This time out in seconds can be set in Setup/User interface/**Auto close inactivity time out**.

1.8 Display organization and management

Additionally to geographic map there are also several extra indicators which make the display information much more effective than a fixed predetermined solution. How to create custom design is explained in **Setup/Layout**. Customization of the display doesn't require any special tools or a computer; all this can be done in the Zeus by using the rotary switches and push buttons.

1.8.1 Display organization

LX Zeus display consists of the following:

- geographic map
- bottom row (navigation boxes)
- indicators (header is also an indicator)

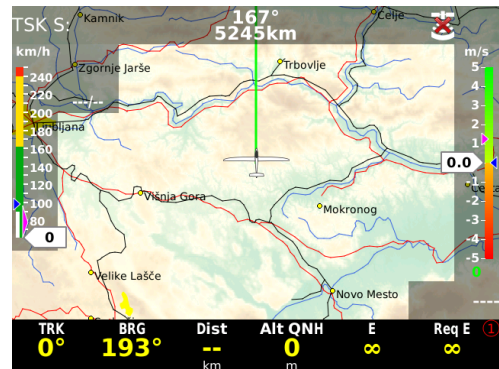

1.8.1.1 Indicators

Indicators are elements of the display, which can be edited (existence, size, position, transparency). See Setup/Layout for details.

Available indicators are:

- Header
- Speed indicator
- Sliding speed indicator
- Variometer (bar)
- Variometer classic (needle)
- Wind indicator
- Final glide indicator (selected MC)
- Final glide indicator (MC 0.0)
- Thermal assistant
- Compass
- Compass needle
- Compass assistant
- Airspace info
- Limitations (Start conditions)

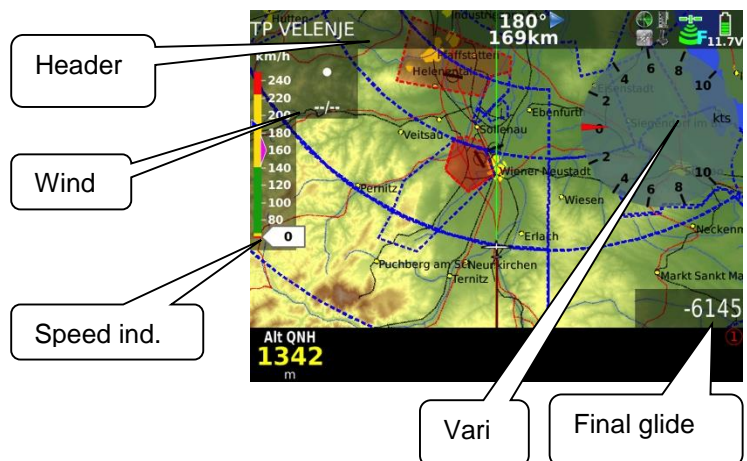

- Map scale
- AHRS
- Flaps position
- Flarm indicator

1.8.1.2 Bottom row customization

Bottom row consists of NAV BOXes which are all custom specific, which means that the pilot is able to create his own configuration. The procedure is extremely simple and also executable during flight. The configuration may differ regarding to mode of operation. The procedure starts with long press on zoom. After long press the first NAV BOX becomes a frame. Rotating of the zoom button can move the position of the frame. As the correct frame position is reached, pressing zoom again will open a list of available NAV BOXes.

Available NAV BOXES are:

- Indicated air speed
- True air speed
- Ground speed
- Vario
- Average vario
- Netto vario
- Average netto vario
- Relative vario
- Altitude QFE
- Altitude QNH
- Altitude QNH in ft
- Maximal altitude QNH
- Altitude IGC
- Altitude GPS
- Above ground level
- Circling radius
- Flight level
- Thermal gain
- Thermal last 30
- Thermal average
- Thermal all
- Set MacCready
- Sink speed
- Final glide (selected MC)
- Final glide (MC 0.0)
- Time on task
- Time on leg
- Time to go
- Required speed
- Task speed
- Task elapsed distance
- Task remaining distance
- Task delta time
- Team code
- Team bearing
- Team distance
- Leg speed
- Recommended flaps position
- Wind speed
- Wind direction
- Air temperature

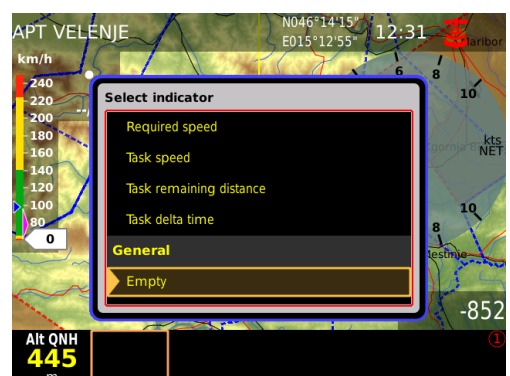

- Distance in NM to selected TP/APT
- Distance to selected TP/APT
- Off course distance
- OLC distance
- OLC home distance
- OLC speed
- Horizontal distance from airspace
- Vertical distance from airspace
- Arrival altitude
- Estimated time en route ETE
- Current efficiency TP/APT/Task
- Required efficiency TP/APT/Task
- Track TP/APT/Task
- Bearing TP/APT/Task
- Radial TP/APT
- Compass heading
- Digital clock
- Analog clock
- Flying time
- ETA (current speed) TP/APT/Task
- ETA (average speed) TP/APT/Task
- ETA (MacCready speed) TP/APT/Task
- GPS position
- Battery
- GPS signal

To terminate the process, press the volume button.

There is an **infinite number** of bottom rows available, selectable with **1-4** push button. To create a new row simply press 1-4 and a new row will open. The display configuration may consist of one, two or three bottom rows. See Setup/Layout for details.

1.8.1.3 Header customization

Customization of the header should be done in the similar way as by bottom row. After a long press on volume the customization can start. Size of indicators can be adjusted by rotating Volume button. Box types can be selected after press on Zoom button. Rotating the zoom button will give the option to select the position for the indicator.

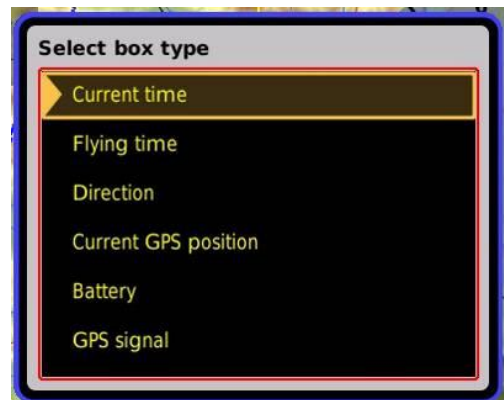
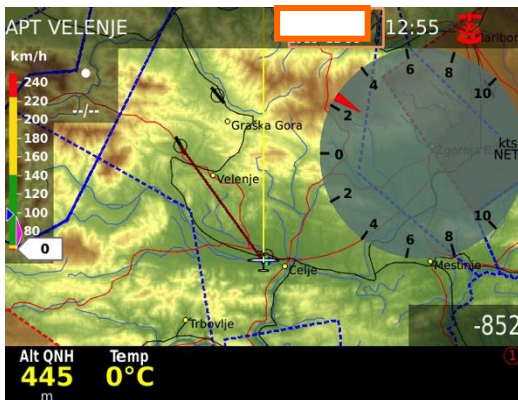

2 Setup

Setup menu is available after short press on **SETUP** labelled push button. The menu is divided into two sections (Pilot and System settings). **System settings** are settings that are valid for the whole system and are not pilot specific data. Pilot connected items may vary from pilot to pilot and depend on individual requirements. Suitable symbols with text will help you to find the menu of interest.

- use Zoom button and rotate it to find out menu of interest (selected menu size will increase)
- use push function of Zoom to enter menu.

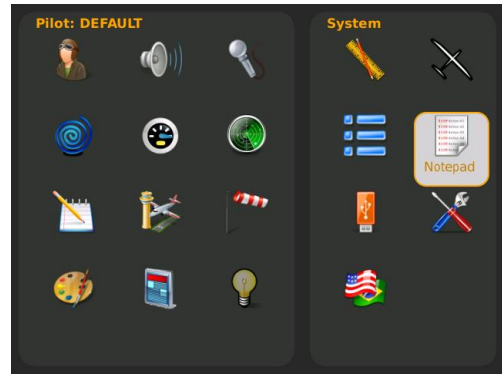

2.1 Pilot specific settings

The data stored in this part of Setup are pilot specific data. After pilot selection during booting, the data of individual pilot becomes active. All settings are saved to the personal saved pilot profile and are active when the pilot is selected (reserve altitude, logger settings, NAV BOX line, layout settings, task colours etc...)

2.1.1 Pilot



Pilots **name** and certain personal data can be stored. All stored pilot names will be offered during booting. Selection of one pilot is mandatory. The system offers one name called as **DEFAULT** - can be used as a default pilot. Furthermore plenty of empty positions are offered and this can be used for pilot names input. Additionally to the name some additional parameters can be entered, such as pilot's **weight**, **default ballast** and **reserve altitude** – all that will be calculate into final glide.

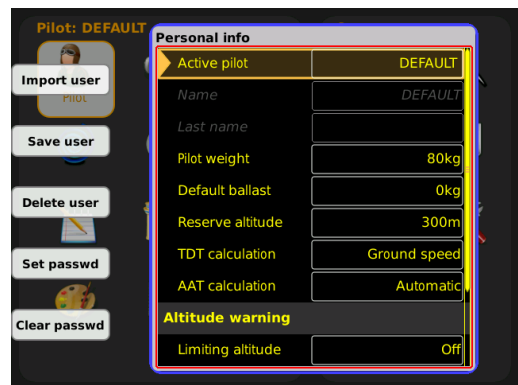

Note!

All settings active at the moment of new pilot creation under "Pilot" will be adopted.

2.1.1.1 TDT calculation (task delta time)

This information can only be visualized as navbox and present only in case of task time being set. If task time is set the unit will recognise this task as assigned area task (AAT). The only function of TDT is to inform the pilot of early or late arrival.

For TDT calculation you can choose between 4 different options:

- Average task speed is based on current task speed.
- MacCready is based on actual based MC value
- Ground speed is based on average ground speed in last 20 seconds.
- Combined (default*) is based on multiple parameters including: selected MC, wind sped/direction, polar, bugs, ballast, reserve altitude.

2.1.1.2 AAT calculation

To help the pilot to optimize distance inside sector we offer pilot equidistant lines. This feature is only available in automatic AAT mode. Flying along this lines will not increase the distance but only lose time on task. You should fly perpendicular to the lines.

AAT calculation offers two options:

- Automatic (default)

This method doesn't need any pilot assistant at all, so pilot can turn to next turn point at any time without using any command. Zeus will automatically detect optimal point in every sector on task. Switch to next turnpoint is performed by

 - Reaching the line which is crossing centre of the sector or already moved turnpoint. Reaching this point will only switch navigation to next turnpoint (for your information). You can still proceed inside this sector and Zeus will find optimal position inside the sector to start new leg. New leg in statistics will start automatically when optimal point is reached.
 - Leaving active sector. When you are more than 5km out of the sector. This is done only if there was no automatic switch inside sector (you didn't cross the line over center of sector or moved point) or if you didn't manually press Next TP button inside the sector.
 - Using Next TP button. You can always use this command without influencing statistics. You will change only navigation data.

- Manual requires manual action in every sector on task. You need to press Next TP button to switch to next Turnpoint. Position at which next tp button was pressed is then used for task statistic calculation. In case of wrong decision pilot should use leg restart function, and when he is ready again he should press next TP again.

Limiting altitude means setting of altitude limit that will turn on the altitude warning alert. You can also save user (pilot) settings to the USB stick and import user by pressing the buttons: **Import user** (VARIO/FLARM) and **Save user** (TSK/MOVE). There is also an option to put a password to each pilot profile, to prevent, that other pilots flying with the same unit will be able to change settings to the pilot (this function was especially developed for flying in the aero club). After press on clear password a password will be removed, also valid for delete user.

2.1.2 Audio settings



This menu defines audio configuration. The audio generator is a part of the vario unit (USB D 60), but settings are stored in LX Zeus.

Speed command mode:

- Defines audio in SC, there are several variants the most common used setting is **both** which means no beep indication by positive deflections.

Use **Test vario** option to play the audio variant. It is important to change over to SC before test; otherwise vario audio variant will be reproduced.

Speed command volume:

- Defines audio volume in SC, may be increased decreased...

Vario tone:

- Defines audio in vario mode, you can adjust frequencies and also types of audio, use **Test vario** after adjustment

The frequencies set are also valid for SC audio.

Alarm: The audio generator is also capable to generate some alarms (warnings), combining two frequencies. Set frequencies and time intervals and use Test to check.

Audio Unknown

General audio	
Speed command mode	Both
Speed command volume	High
Vario tone	Linear positive
Zero frequency	500Hz
Positive frequency	1500Hz
Negative frequency	200Hz
Test vario	
Alarm	
First frequency	200Hz
First frequency duration	300msec
Second frequency	2000Hz
Second frequency duration	300msec
Repetitions	10
Next alarm	1s
Test alarm	

2.1.3 Voice



In case that LX Voice Module is a part of the system following settings can be arranged. Enable or disable all functions is possible after press on screen buttons.

Voice unit should be selected at SETUP / GLIDER – voice unit present (icon – CHECK)

Volume:

- Voice volume: defines volume of expressed messages
- Vario mixer: defines volume proportion Audio/Voice

General Information:

- Enable or disable general information about pilot, plane and elevation...

Task Information:

- Enable or disable information about task, turn point, final glide and time

Warnings:

- Enable or disable warnings

Flarm:

- Enable or disable information about Flarm and warnings

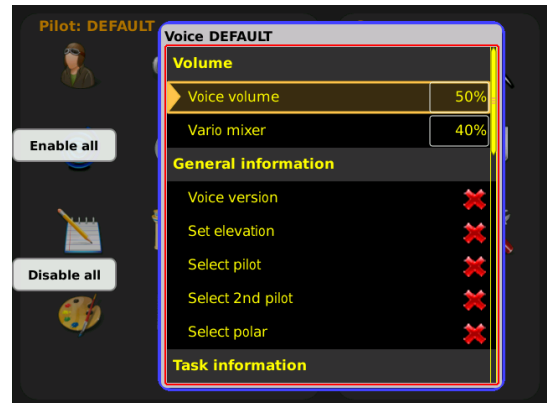

2.1.4 Vario settings



Settings in this menu define vario characteristics and some other important inputs connected to vario and speed command.

Vario:

- vario filter defines dynamic of vario needle. Lower number means faster reaction and vice versa.
- smart vario
- Integration time (display on vario unit)
- vario scale, three options (2.5, 5 and 10 m/s) (5, 10 and 20 kts, if defined in Units)

Other:

- Silence range, defines no audio area around zero by speed command
- SC switching threshold, changeover speed which will change from Vario to SC in case of Auto setting
- Automatic SC switching, defines way of automatic change over to SC
- External switch mode*, determinates external SC switch status which change over to SC

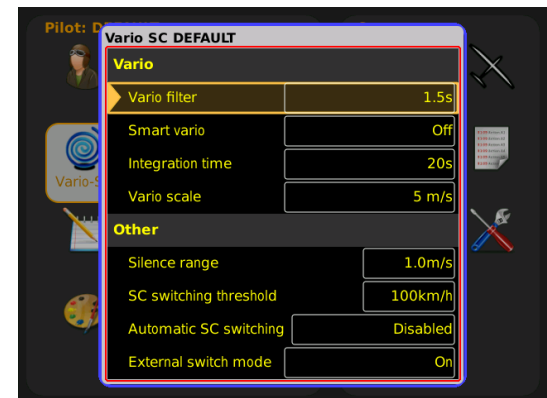

* LX Zeus has a connection for an external speed command switch, which is **wired to the vario unit** (USB D 60). With using an external switch it is possible to switch between SC and Vario manually. Setting the **External switch mode to ON** means that closing of the switch will cause SC mode, and setting **External switch mode to OFF** means that closing the switch will select Vario mode. There is a third option by setting **External switch mode to Toggle** and connecting a push button. Now each press will toggle between SC and Vario (obligatory setting when using the LX Remote).

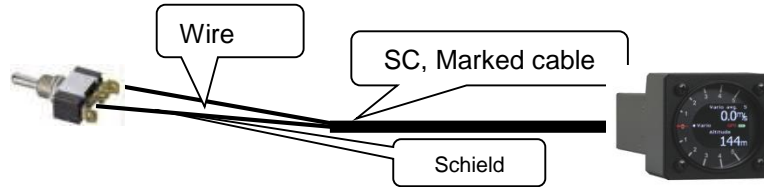

Wire	Shield	Open	Setting: ON	Status: VAR
Wire	Shield	Open	Setting: OFF	Status: SC
Wire	Shield	Closed	Setting: ON	Status: SC
Wire	Shield	Closed	Setting: OFF	Status: VAR

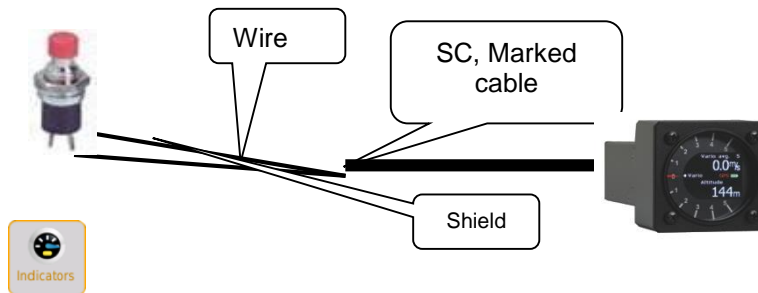

2.1.5 Indicators



By Indicator, the vario indicator with its mechanical needle and colour graphic display is meant. One indicator is incorporated into USB D 60 vario unit. The system is also capable to drive secondary indicators. Secondary indicators may be simple repeaters or may also indicate different data sets, all depends on indicator address. Vario unit is always addressed as Number 1, secondary indicators can be addressed from 1 up to four.

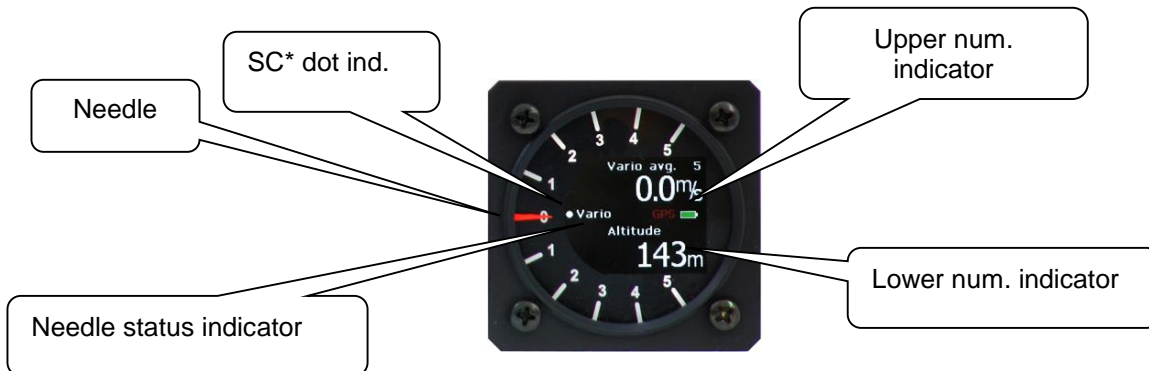

In general every indicator consists of: mechanical needle, SC dot, needle status indicator, upper / lower digital indicator, battery indicator and GPS signal indicator. It is important to point out that the settings should be done separately for vario and SC mode of operation. A **radial moving dot** serves as a continuous speed to fly indicator, this cannot be changed.

Some explanations of terms:

- Vario needle : means needle function in vario mode, alternatives; vario, Netto*, SC, Relative**
- SC needle: means needle function in SC mode, alternative; Netto, Relative, Vario
- Vario upper nr: display indication by option: integrator, time, flight time, leg time
- Vario lower nr: display indication by option: altitude, distance, glide difference, true air speed, leg speed, QNH, flight level
- SC upper nr: display indication by option: integrator, time, flight time, leg time

- SC lower nr: display indication by option: altitude, distance, glide difference, true air speed, leg speed, QNH, flight level



* Vertical speed of air mass
 ** Vertical speed – 0.8 m/s

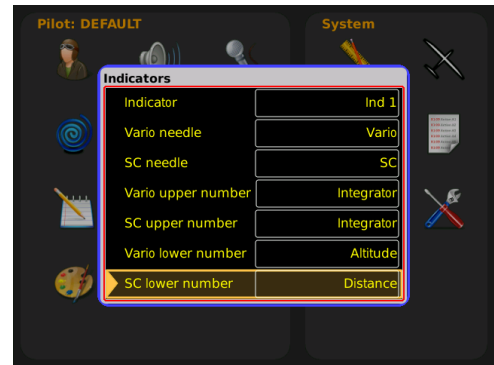

Note!
 Setting **Altitude QNH** means Altitude indication in ft, doesn't matter what is set in Units.

2.1.5.1 Secondary indicators

Secondary indicators should be connected via 485 system bus. There are three 9P connectors at the back of the unit. All contacts are absolutely parallel, so it doesn't matter which one is occupied. The unit can be also used as 485 system bus splitter. To define indicator number use **DIP switches** which you find at the back of the unit.

Note!
 Units having Adr1 will simply repeat what is displayed on the vario. Higher addresses make different sets possible.

Number	Switch
IND 1	
IND 2	x x
IND 3	x

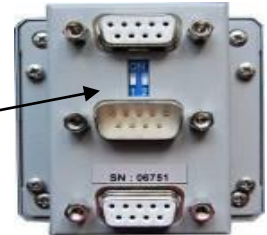

Note!
 Indicators which operate in second seat, should be connected to second seat with 485 bus

After indicator functions have been defined, switch the unit off and then on again, this procedure will memorize the settings and you will be able to adjust settings on Zeus.

2.1.6 Flarm



This menu is mainly used to adapt flarm objects visualization on Zeus display. The only executive command which can be send to flarm unit is privacy mode. Activation of privacy mode will send flarm unit into so-called stealth mode, which means that the data which are transmitted to and from flarm unit are limited.

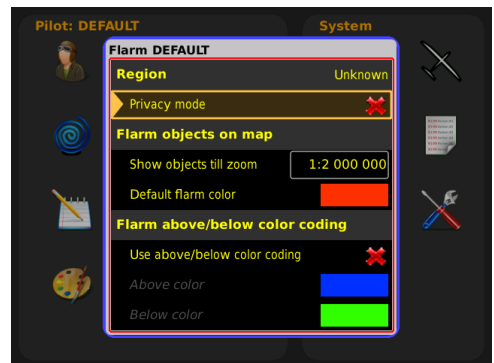

Others commands:

- show objects till zoom command (defines zoom till flarm object will appear on the map)
- default flarm collar (custom designed color of flarm objects)

- use above/below color coding (makes possible to define above and below color of flarm objects)

2.1.7 Logger - Flight recorder settings



LX Zeus uses Colibri II as an IGC approved flight recorder. Both units collaborate so that all necessary settings can be sent to flight recorder (Colibri II) via Zeus meaning that no actions on Colibri II are necessary.

Recording interval is set to 9 seconds per default; event repetitions are set to 20 and event fix interval to 1.

Extra recording means that user can select also recording of Ground speed into log file.

This menu is usable only if Colibri II is connected to Zeus. If you change settings, these settings won't change in Flarm or any other Loggers.

In a double seat configuration the second seat pilot is also able to change logger settings. The process is equal as on first seat.



Note!

Pilot and glider data are sent after task **Declaration** process has been executed. See section flying.

2.1.8 Airspace management



All settings connected to AS management are available in this menu.

Note!

Hide above airplane option will remove airspace sections which are higher than set. This will reduce load on graphic page significantly.

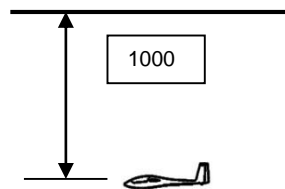

Example of Hide airspace above

- You can set maximal vertical and horizontal distance to which airspaces in Airspace info box on map are displayed. If there isn't any airspace that fulfill this conditions Airspace info box will not appear.
- Hide above QNH altitude to disable airspaces that are above set QNH altitude.
- You can disable audio warnings (on vario "didldil") when airspace warning appear on the



- Zeus (warning with dismiss buttons).

Default warnings for airspaces are set to 2 km horizontally and 100 m vertically, but these warning settings can be adjusted. Warning timeout at take off is pre-set to 5 minutes, which means, that first 5 minutes after take off there won't be any airspace warnings.

Show on zoom, defines appearance of particular airspace sections on the display. Appearance is connected to zoom. AS warning can be set as active or as not active (☒).

2.1.9 Wind



LX Zeus is able to measure wind under different methods. The method can be selected in **Wind** menu. Wind calculation results are shown as a standalone indicator in main graphic page and also as NAV BOX if set.

Pilot can choose between two circling methods, which measures wind during circling and two straight model methods during straight flight

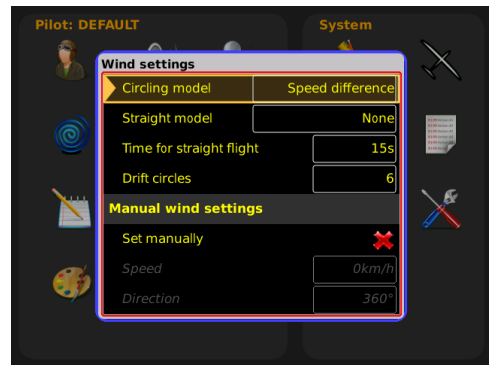

2.1.9.1 Circling method

- **Speed difference** is based on ground speed (GS) oscillation due to wind influence in circling. The method is active exclusively during climbing process. During straight flight the wind data remain unchanged. The process is started (automatically) after circling is detected. After two* circles wind indication (direction and speed) will be updated. The method is based on fact that the ground speed is affected by wind. GS is maximal by tailwind and minimal by head wind. This phenomenon is used by GS difference calculation method. To increase reliability two turns are necessary for a new result. To get result the pilot should do two turns as a minimum, more turns will improve result. Note that up to 90 degrees more is required, as some time is needed to detect circling status. It is important to keep constant speed during circling.
- **Position drift** calculates wind regarding to position offset during circling. Such a method needs more circles (from 4 up to 8). Number of circles should be set in **Drift circles** option. If both methods, straight model and position drift are selected Zeus indicates a combined result.

2.1.9.2 Straight model

- **None:** if you select none, you will have the wind from the latest circling method
- **Iterative:** This method will update wind even in straight flight, but when you are circling, Zeus will automatically switch to circling method. The result of this method is wind speed and direction. This method does not supplement Head/Tail method and gives good results in case of accurate IAS reading.
- **Compass:** Compass module should be connected to the unit on 485 bus. Wind calculation is based on well-known wind triangle method. Airspeed, ground speed and wind create a triangle of vectors. A compass device offers magnetic heading, which defines direction of airspeed vector. To measure wind by compass a straight flight with speed and direction as stable as possible is required.

***Compass** is a standalone electronic device which can be connected to LX Zeus 485 bus. Integrated AHRS option also offers the same functions. The unit's task is delivering of magnetic course to Zeus computer.

Note:
Compass option is available only if compass is connected.

- **Head/Tail** – no circling method needed (shows difference between GS and IAS)
- **Time for straight flight:** time in seconds that will be taken for one measurement (valid for straight model). Longer period means better result. Valid only for Compass method and not for Component.
- **Drift circles:** means how many circles are required to calculate the position drift.
- **Compass assistant:** is a special symbol that appears on the display and helps to keep flight parameters (speed and direction) stable during calculation.

2.1.9.3 Manual wind settings

- Set manually - user can set manually wind speed and direction

2.1.9.4 Influence of wind in final glide

The actual wind data (speed and direction) influences the final glide calculation. In task mode the final glide indication is based on remaining distance over all TP until finish (not over already flown turn points). Wind influence for individual legs is based on actual wind data. Using of component method will define wind direction on actual track and this value will be taken into final glide calculation.

2.1.10 Graphics (User Interface)



In User interface the pilot can adjust most of graphics, except for the layout which has its own menu. All settings are saved to currently selected pilot profile.

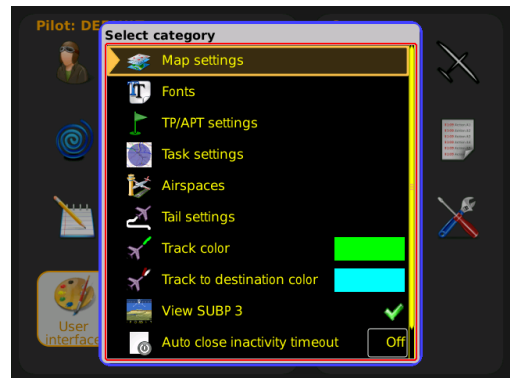

2.1.10.1 Map settings

Under map settings menu user can select map palette colours, glider image, map orientation, distance circles on the map, range...

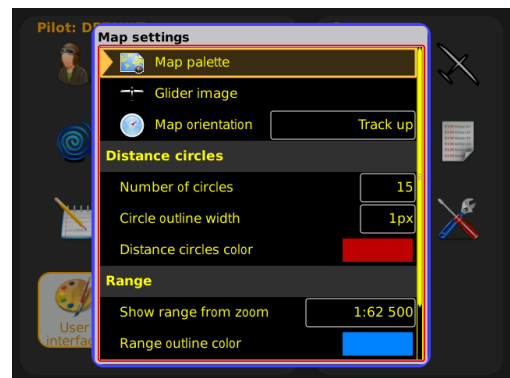

2.1.10.1.1 Map palette

To change map colours regarding to pilot personal requirements, use this menu. There are 12 different map schemes offered. You can also edit 5 user defined map schemes. The last option is to disable map (very useful if you want to see only airspaces and task data).



2.1.10.1.2 Glider image

Glider image icon can be in all colours and can also be adjusted by size.

Default:

- Colour white
- Size 25 (maximum size can be 60)



2.1.10.1.3 Map Orientation

The map orientation of LX Zeus can be used in three different ways as follows:

- Track up (The glider always points to the top of the screen)
- North up (North is always on the top of the screen)
- Track circ north (Combination of track up and north up regarding to flight status (circling, straight flight))

2.1.10.1.4 Distance circles

In this section it is possible to select number, size and colour of distance circles on the map.

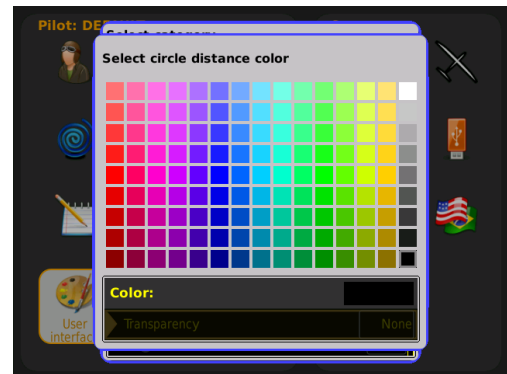
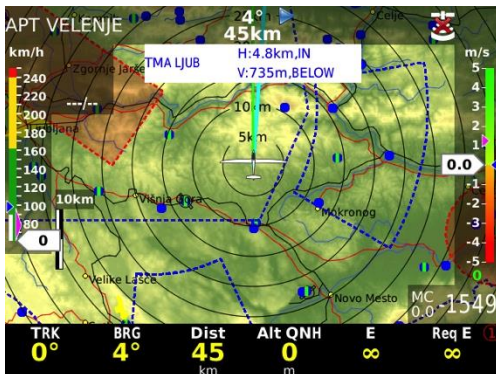

2.1.10.1.5 Range (graphic glide reach)

Activation of this feature shows glide range curve from actual position to all direction. This curve is not necessary a circle due to the in calculated elevation.

Show range from zoom defines appearance of feature regarding of zoom settings (Set on never - function not active)

Next three setting are connected to **fill colour**, **outline colour** and **outline width**.

Note: Range is than displayed only in TP and APT view.

Range is calculated and displayed by using following parameters:

- Reserve altitude
- glider polar
- MC
- ballast
- bugs
- elevation
- wind

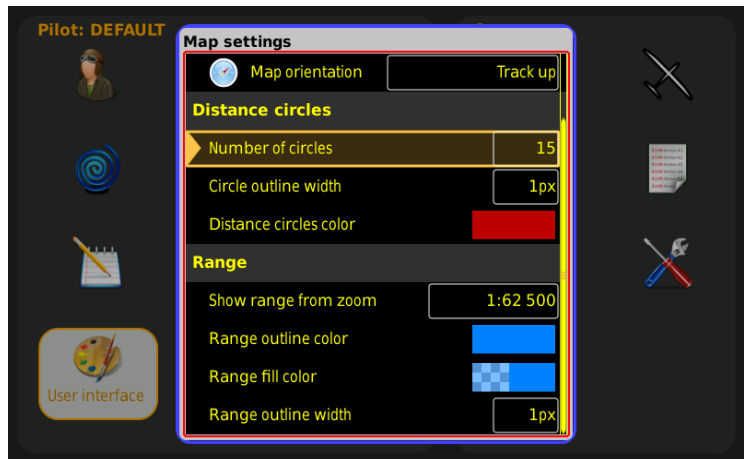
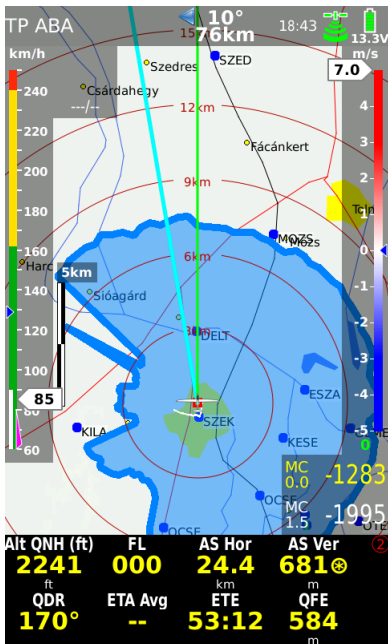

2.1.10.2 Fonts

Users can define many fonts in the system:

- Map city (default 15px)
- Tournpoint labels (default 15 px)
- Airport labels (default 15 px)
- Flarm objects (default 17 px)
- Navbox values (default 30 px) – here you can change fonts of bottom row
- Header navboxes (default 24 px) – here you can change fonts of top row
- Distance circles (15 px)

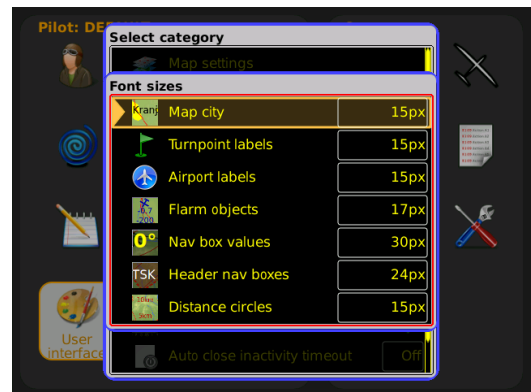

2.1.10.3 TP/APT settings

In this menu you can adjust appearance and length of labels of TP and APT on the map at different zooms.

- **Show TP till zoom** (adjust visibility of TP at wanted size ratio)
- **Show TP labels till zoom** (adjust visibility of TP labels at wanted size ratio)
- **TP labels length** (adjust number of label characters shown on the map)
- **TP label color** (select Label color)
- **Show APT till zoom** (adjust visibility of APT at wanted size ratio)
- **Show APT labels till zoom** (adjust visibility of APT labels at wanted size ratio)
- **APT labels length** (adjust number of label characters shown on the map, ICAO code can be also selected)
- **APT label color** (select label color)

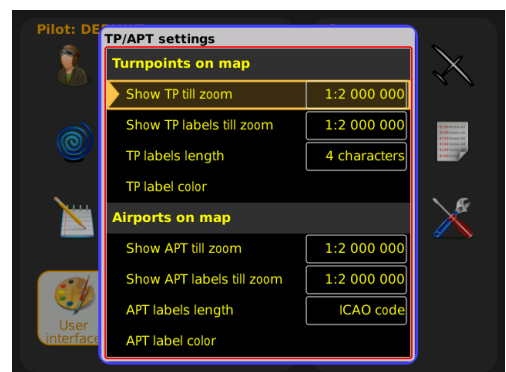

2.1.10.4 Task settings

Start lines/zones, turnpoint zones and finish lines/zones can be given different default colours from a large palette. It's also possible to change their outlines, fills and outline widths. There is a different colour possible for active or inactive zones.

AAT zones can also show equidistant lines. Equidistant lines show in AAT zone in which direction you are not gaining any speed on task.

Default task colours:

- Active zone: pink
- Active start/finish line: red
- Inactive zone: cyan
- Inactive start/finish line: teal
- Legs yet to cover: royal blue
- Active leg: yellow
- Covered leg: green
- Course to next TP: cyan

Transparency can be set at all colours.

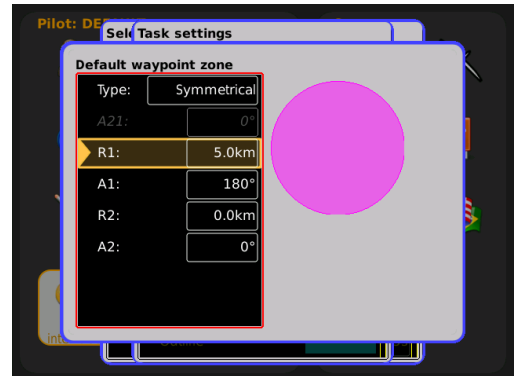
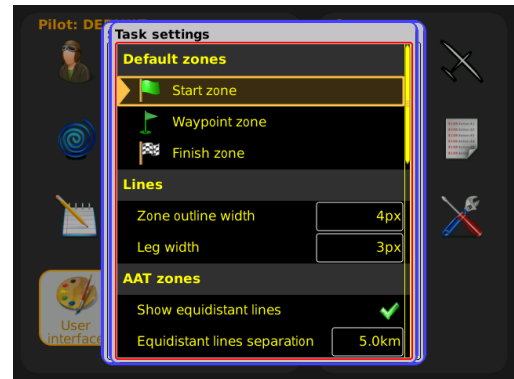

2.1.10.5 Airspaces

User can define colours and width of airspace sections that will meet personal preferences.

Default colours are:

- Selected/active airspace: Blue
- Controlled area: Red
- Prohibited area: Red
- All other: Blue



2.1.10.6 Tail settings

Track of last flown minutes and colours of positive, zero and neutral vario can be defined in this setting. **Draw tail for last** is default set to Always.

Vario color coding setting allows you to enable or disable color coding. If you disable this function, you can still choose in which color your track will be shown.

Default vario track colours are:

- Negative: Blue
- Zero: White
- Positive: Red
- ENL: Dark grey

The tail will become wider or narrower due to changing vario values. Default tail width is 2 pixels. For each 1 m/s, the tail will become wider by 2 px, up to 16 px (to 5 m/s).

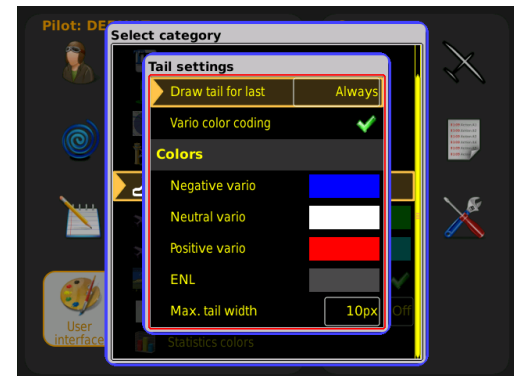

2.1.10.7 Track colour

This is in fact an extension of the track vector and shows the pilot where his flight will continue. Default track colour is Green.

2.1.10.8 Track to destination colour

This is the line that connects the actual position of the glider with the destination point (track to destination colour). Default track colour is Cyan.



2.1.10.9 View SUBP 3

Subpage number 3 can be enabled or disabled.

2.1.10.10 Auto close inactivity time out

LX Zeus is monitoring push buttons and rotary switches during editing process. If no action will be detected the program will change back to the last used navigation page in a predefined time slot. The time is flexible and can be adjusted from 6 up to 60 seconds and also be disabled (off). If the time is set to off, than the page will disappear only by pressing the Volume knob (escape button). Default time is 30 seconds.

2.1.10.11 Statistics colours

The colours of statistics page graphs can be custom designed.

Default colours are:

- Background: Black
- Text: White
- Graph normal colour: Grey
- Graph highlight colour: Green

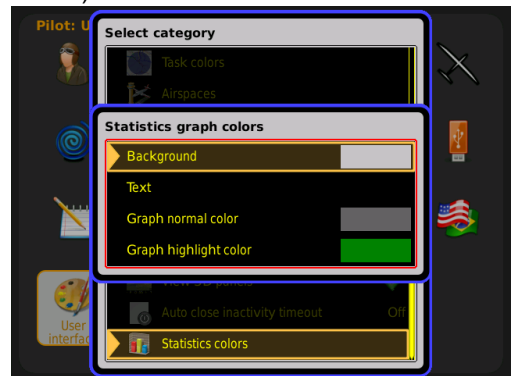

2.1.11 Layout

LX Zeus offers a very useable feature that makes it possible to change the main graphic page by pilots personal preferences. As mentioned in previous section the main display consists of:

- map
- bottom row
- indicators

The main difference between indicators/widgets and the rest two options (bottom row and header row) is that indicators can also be **disabled** and moved or resized.

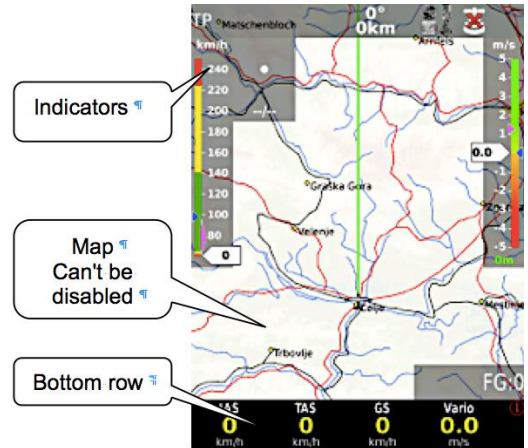

2.1.11.1 Layout edit procedure:

- go to setup / **Layout**
- **press Zoom** knob on Layout
- **check** one two or all three panels to edit (TP,APT,TSK)
- rotate zoom button to select **Edit** and **press Zoom**
- now a screen will open with an orange frame (**orange frame** means what is selected – map, row or indicator)
- **select indicator, row or map** you want to edit by **rotating Zoom** (selection means frame)

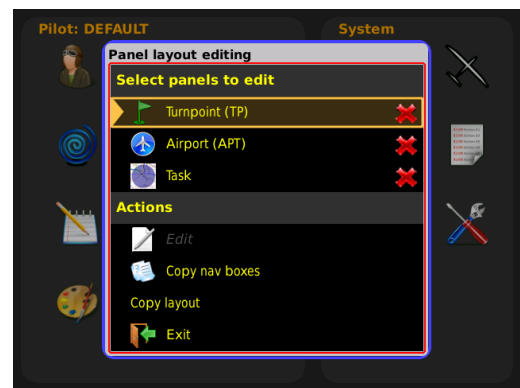

Header selected



IAS indicator selected



2.1.11.1.1 Customization process of moving and resizing

Move of display element

- **Select** indicator
- **Short press Zoom** (a significant cursor symbol will appear in the middle of the indicator)
- use **zoom** and **volume** buttons to move the indicator



Resize (expand or compress)

- **next press** on zoom will open similar window but now with a **cross** through the selected indicator
- use **zoom** and **volume** buttons to resize it
- **terminate** the process after pressing the volume button (a **layout saved** message will appear)



Note!

After saving the new layout it may occur that nothing changed on the screen, because you are at the wrong navigation screen (if you changed the TP and you are at the APT screen then it seems that nothing has changed). Press an APT button to select the customized screen.

Terminate proces

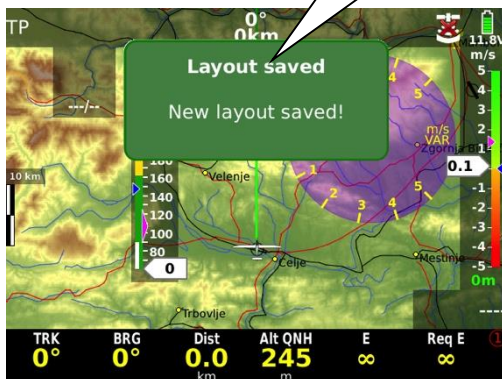

Cross-ready to be resized

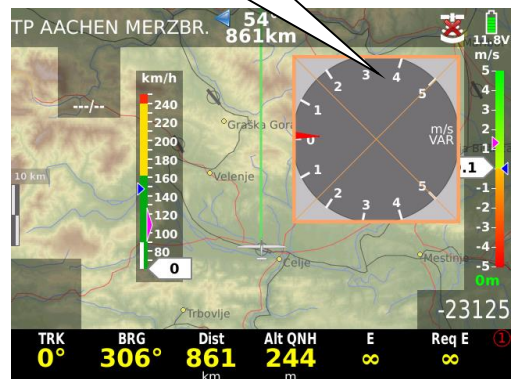

2.1.11.1.2 Selecting/Deselecting and editing of indicators

Editing process:

- Select the indicator that you want to customize (an orange frame will appear).
- Make a **LONG** press on **Zoom** knob (if you won't make a long press than you will get the option to move or resize it!)

Selected indicator to be customized

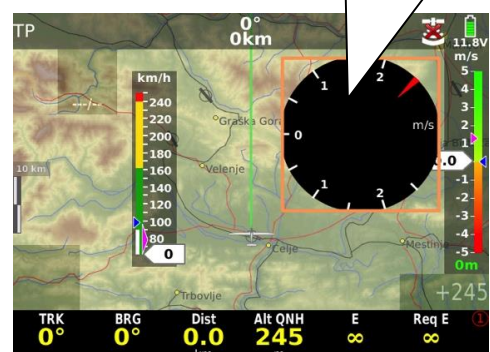

Indication, that the button **wrong** press was made - **SHORT** and not **LONG**

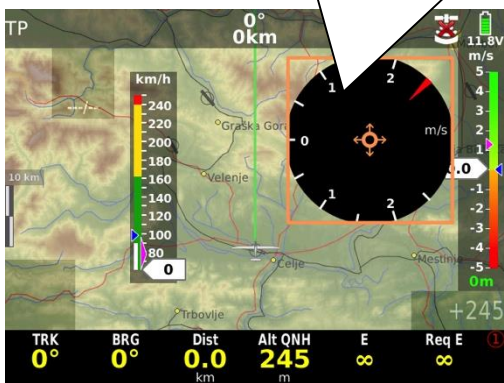

After a **LONG** press a Properties/Actions menu will open – correct!

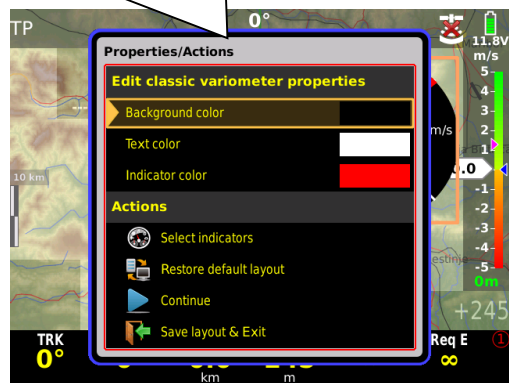

- Select the colour you want to change (rotate Zoom) and make a **SHORT** press on **Zoom** - a new window (Edit Background colour) will open
- Now you can change the colour simply pick one from the palette and **press Zoom**, or you can change the colour by using RGB code. If you have picked one from the palette and you want to add transparency, simply go back again. Edit Background colour window (**press Zoom**) and go to transparency (**press Zoom**). Rotate zoom to change the transparency you want, confirm it by **pressing Zoom** and **press Volume** to escape.
- To terminate the customization **press Volume** first to escape from Edit Background menu and then again **press Volume** to escape from Properties/Actions menu. An edited indicator will appear on the screen that you have customized.

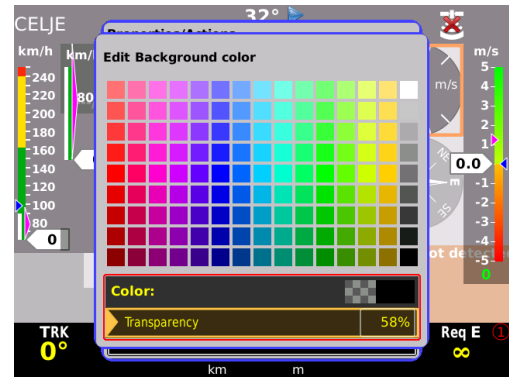

Note!
To escape from Edit Background colour menu you don't necessarily have to press **Volume**, you can simply wait 15 seconds and the screen will go back to first (Properties/actions) menu

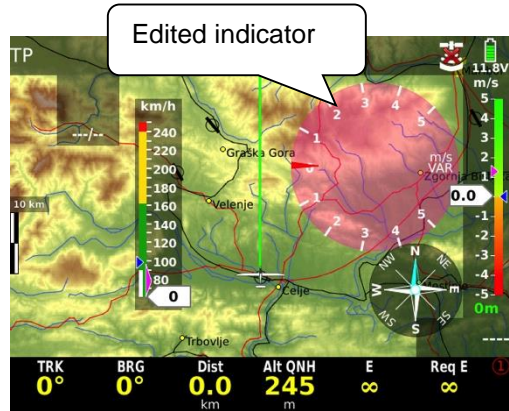

Selecting/deselecting process:

- go to Layout in Setup, press Zoom, select the screen that you want to edit and go to Edit (press Zoom)
- Make a **LONG** press on Zoom and the window Properties/Actions will open



- Select row: **Select Indicators** and press Zoom and a window **Select indicators for chosen panels** will open
- Now select the indicators that you want to have on the screen, or deselect that you don't require. Select and deselect them by rotating and pressing the Zoom knob.

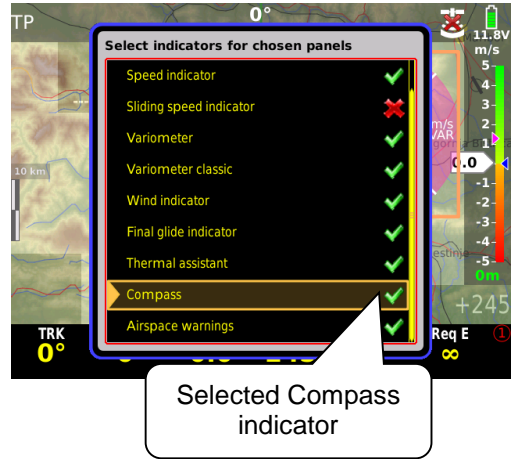

- To escape, press Volume and the selected indicator will appear on the screen

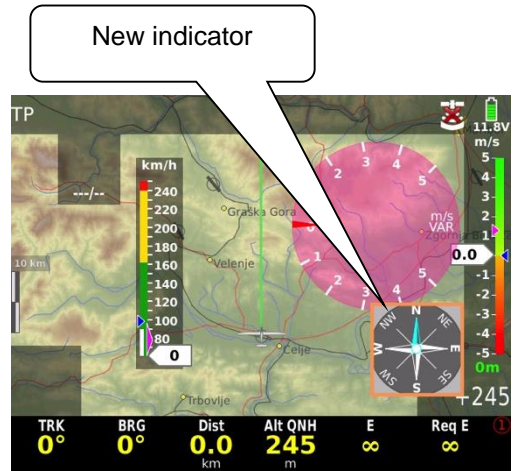

Properties/Actions window

This window appears by LONG press on Zoom knob. In this window colours can be adjusted for selected indicator and also some other settings such as:

- Number of rows for NAV BOX bottom row
- Scale size for Sliding speed indicator

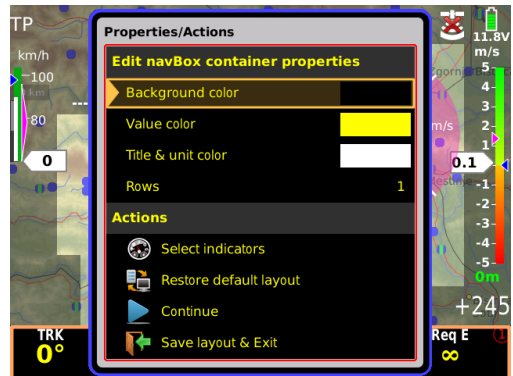

By pressing on the rows below Actions you can:

- Select indicators to be seen on the screen
- Restore your layout to default settings
- Continue with editing indicators
- Save layout and exit with new settings

Map and bottom row are not indicators



Indicators

The following indicators can be selected:

- Header – upper row
- Speed indicator – IAS
- Sliding speed indicator – not the whole IAS – the shown scale can be customized
- Variometer – sliding variometer
- Variometer classic – rounded variometer
- Wind indicator – shows direction and speed
- Final glide indicator (selected MC)
- Final glide indicator (MC 0.0)
- Thermal assistant
- Compass – rounded compass
- Compass needle
- Compass assistant
- Airspace info
- Limitations (start conditions)
- Map scale
- AHRS
- Flap position
- Flarm indicator

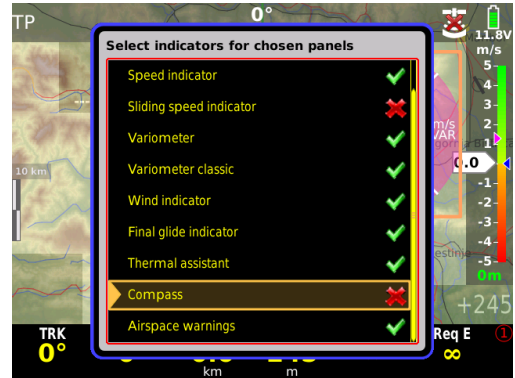

Note!
 Restore to default will
 Restore back to factory
 settings.

Map – NAV BOX transparency

Map can be only resized. If you want to have your NAV BOXes transparent, than **the map should be maximum stretched** and the bottom row should be set to transparent.

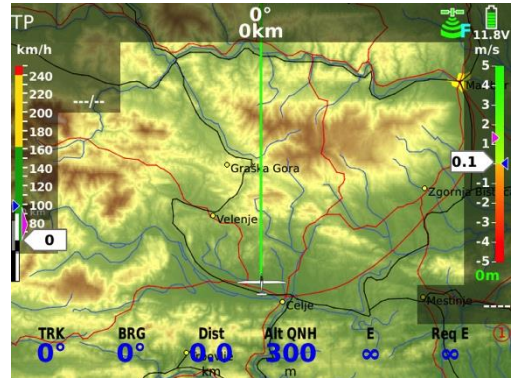

2.1.11.2 Copy NAVBOXes

Under Layout user can copy NAV BOXes from one screen to another or to have nav box configuration the same on all screens (TP/APT/TSK). User should prepare its NAV BOXes on one screen that is also a reference panel for other screens. When a reference panel is selected, user should check destination panels, where the NAV BOXes will be copied. After that a press on Copy from reference to destination will be needed.

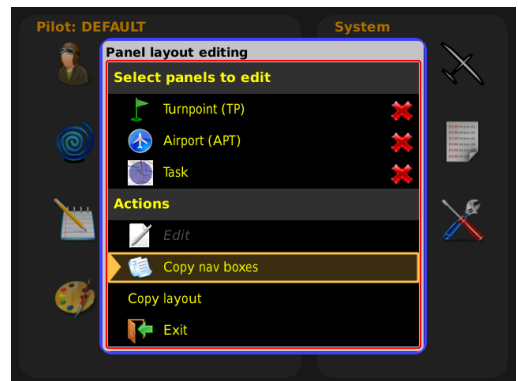

2.1.11.3 Copy layout

User can copy one layout to one or both remaining layouts.

Under **Reference panel** you choose the layout you wish to copy. Under **Destination panels** you choose to which layout to copy the reference layout. After this has been sorted out, select under operations- **Copy from reference to destination**. A green message will appear, telling you layout was successfully copied and saved.

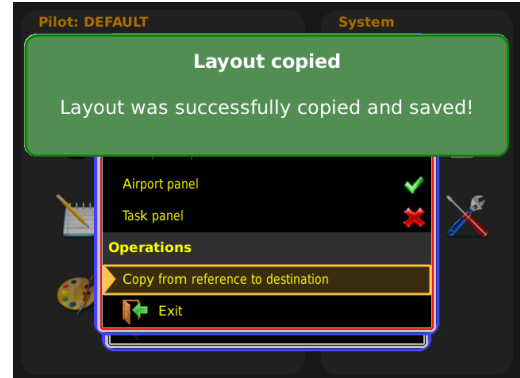
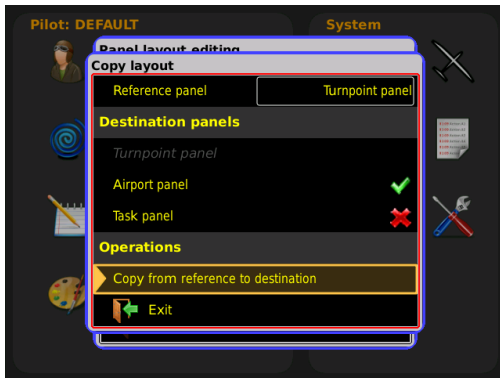

2.1.11.4 NAVBOX as an indicator

NAVBOX can be also added on the map as an indicator. There is no limitation in quantity of NAVBOX indicators on the map. Each NAVBOX can be customized (different colour, transparent).

Procedure:

- TO add a NAVBOX go to Layout and select the screen you want to adjust, press EDIT
- Long press on ENTER button will open a Properties/Actions window
- Move down to "Add NAVBOX indicator)
- To remove it, select the NAVBOX and make a long press on ENTER
- Select "Remove "xy" NAVBOX"

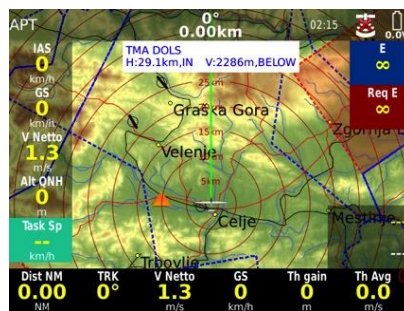
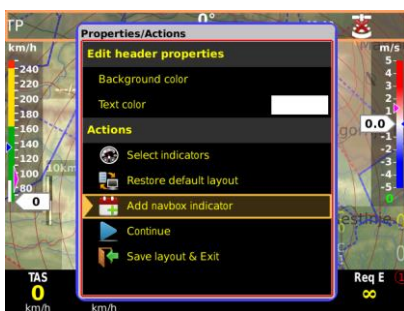

2.1.12 Brightness adjustment



The display used in LX Zeus is a high quality sunshine readable display and its backlight will satisfy the pilot's requirements during the majority of the flight time. In the special case of increased backlight need, the pilot is able to increase the intensity for a limited time (30 minutes). After 30 minutes the backlight will go back to default. After press (zoom) on Brightness icon, a change will happen followed by a clear message.

Note!

Not valid for LX Zeus 4.3, 2.8. Zeus 4.3 does not have the brightness adjustment option.

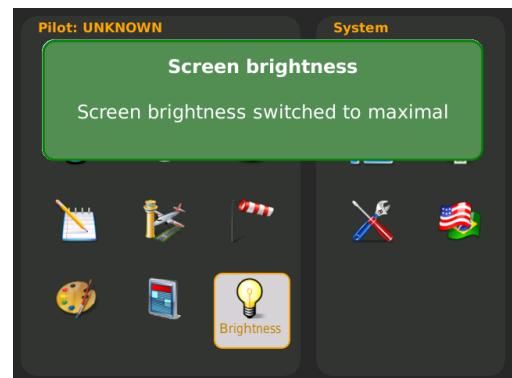

2.2 System Setup

The parameters set in this section are valid for all pilots and are therefore global.



2.2.1 Units

A huge palette of units can be defined in this menu. By pressing the TSK/MOVE or SELECT/NEAR buttons you will press the screen buttons 'Set metric' or 'Set imperial' and all units will change to metric or imperial.

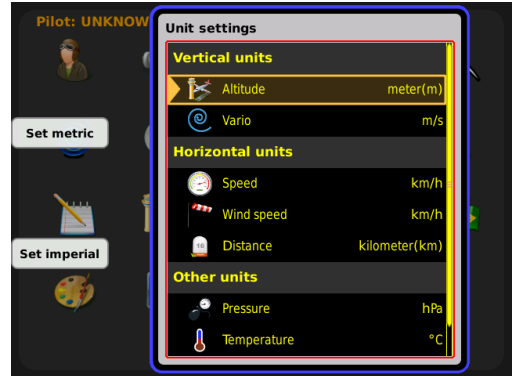

2.2.2 Glider (glider polar selection)



Nearly all glider polars are stored in the LX Zeus memory. Additionally to these standard polars it is also possible to create custom polars, by changing the parameters.

In the glider menu it is possible to add all information about glider such as:

- Competition ID
- Registration number
- Equipment weight
- Polar 1, Polar 2 (not possible from sec. seat unit)
- Speed indicator settings
- Flaps position settings
- TE level (not possible from second seat unit)
- TE filter



Polar 2 is very usable if you have a glider with different wingspan (example: ASG 29 – 15 m, ASG 29 – 18 m). After Zeus is turned on, an option to select your polar will appear.

2.2.2.1 Speed indicator settings

The user can adjust speed markings of IAS indicator on Zeus.

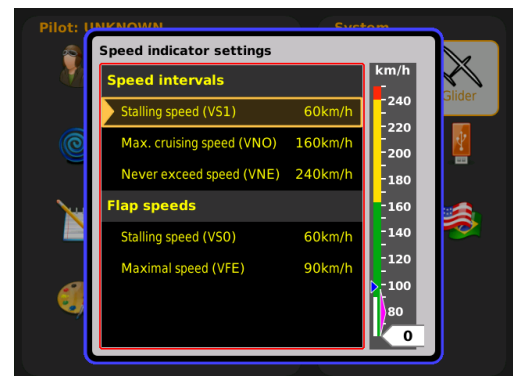

2.2.2.2 Flaps position settings

For gliders with flaps, Zeus offers an indicator on the screen that will remind pilot to change flap position. User must define speeds and number of positions in this menu. An indicator can be selected in Layout as a Flap position indicator or as a Navbox – Recommended flap position.

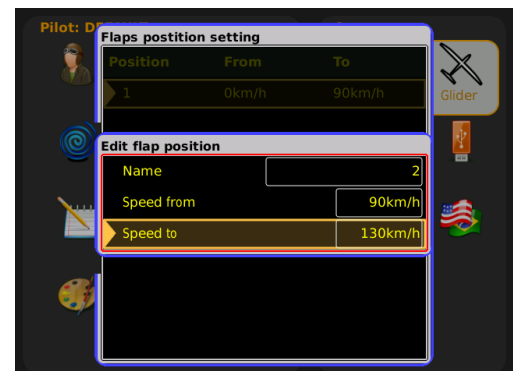

2.2.2.3 TE level and TE filter

TE level***, set TE compensation style, 0% for tube compensation

TE filter***, only valid by electronic TE compensation

The LX system incorporates two configurable electronic filters in the circuitry. The first filter adjusts the time constant and is adjustable between 0.5 and 5 seconds. The 0.5 setting is the fastest while the 5 setting provides maximum damping.

The second filter, called the Smart Vario, is a dynamic filter and controls the rate at which the vario indication moves. When set to OFF, there is no restriction on the rate of movement of the vario indication other than the setting of the time constant filter. When set to 1, the vario indication will not move faster than 1 m/s (2 kts) per second, while when set to 4, the vario indication will not move faster than 4 m/s (8kts) per second. It should be noted that when set to 4, the vario indication will move four times faster than when set to 1.

Summary:

The Smart Vario should not be used in isolation but in conjunction with the setting of the time constant filter. When the Smart Vario is activated, the time constant filter may need further adjustment to provide optimum indications.

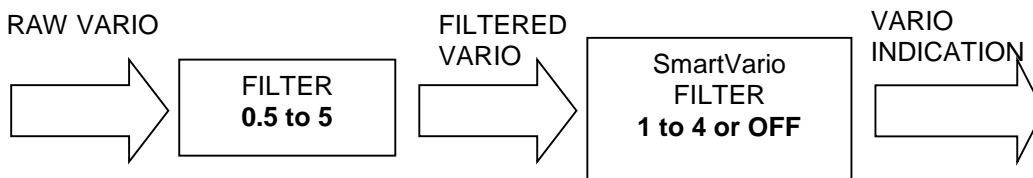

*** LX Zeus has the capability to offer variometer total energy compensation in two ways. Selection of compensation method is done after selection of the % figure. 000% means total energy compensation by using a TE tube. When using this solution the unit does not process compensation, this depends entirely on the TE tube and its installation. After an input of a percentage that is other than zero the special software routines will be activated and will provide an electronic compensation process. The default value is 100% but this can be varied following a test flight.

Note!
Electronic and pneumatic TE compensation requires different connection of tubes.

The TE compensation can be fine-tuned during flight with the following procedure. It is essential that this is only done in smooth air; it is not possible to tune the TE accurately when there is a lot of thermal activity.

- Select 100 % and default **TEF (TE filter)**
- Accelerate up to approximately 160 km/h (75 kts) and keep the speed stable for a few seconds
- Gently reduce the speed to 80 km/h (45 kts)

Observe the vario indicator during the manoeuvre. At 160 km/h (75 Knots) the vario will indicate about -2 m/s (-4kts). During the speed reduction the vario should move towards zero and should never exceed zero (slightly positive indications are acceptable). If the vario shows a climb, then the compensation is too low, increase the TE%; and vice versa. Repeat this procedure and make further adjustments if necessary.

The **TEF** (TE filter) is the compensation delay. Larger numbers will increase the delay and vice versa. During the first test is recommended to use TEF 4.

Electronic TE is only effective when the pitot and static sources are co-located and the pneumatic lines to the instrument are approximately the same length. The best sensor to use is the combined pitot/static Prandtl tube. If problems are experienced with the electronic TE compensation, then the most likely cause is the glider's static source. The static source can be checked by changing the connection of the pneumatic tubes for electronic compensation, and then setting the **TE**: to 0%. In still air, accelerate to approximately 160 km/h (75 Knots) and reduce the speed. Observe the vario indicator. If the static source is good, then the vario should immediately start to move showing a climb. If the needle initially shows increased sink and then moves to a climb, the static source of the glider is unsuitable and there is no way to provide successful

TE compensation electronically. The use of a dedicated and accurate fin mounted pitot/static source such as a Prandtl tube might help.

There are two ways by which the vario units can be corrected for total energy; electronic TE compensation based on speed changes with time; and pneumatic compensation with a TE probe. When using pneumatic compensation by use of a TE probe the quality of the TE compensation depends entirely on the location, size and dimension of the TE tube. The installation must be leak-proof.

Note!

If electronic TE compensation is selected, then the TE (Pst) port should be connected to a good static pressure source. If pneumatic compensation is selected, then the TE (Pst) port should be connected to the TE probe.

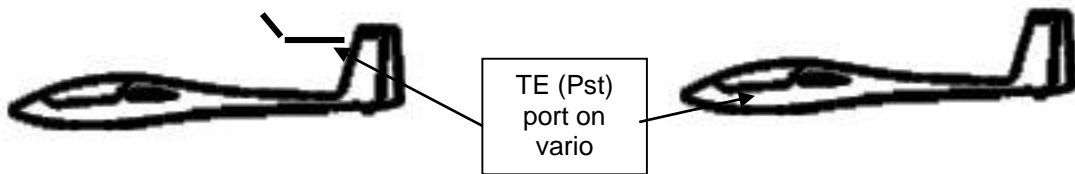

Compensation with TE probe

Electronic compensation

2.2.3 Checklist

Check list can be made on LX ZEUS system. After press on screen button NEW there will be a checklist for specific operation “example: Take off”. After press on Edit List a window Edit Checklist will open. Here it is possible to add operations and actions.

To go through Checklist, simply select the checklist and press Enter. To confirm an action press enter until the end of checklist list.

It is also possible to create and edit your checklist on a computer. Use **Check list editor software for Lx Zeus** which can be download from www.lxnavigation.com under software.

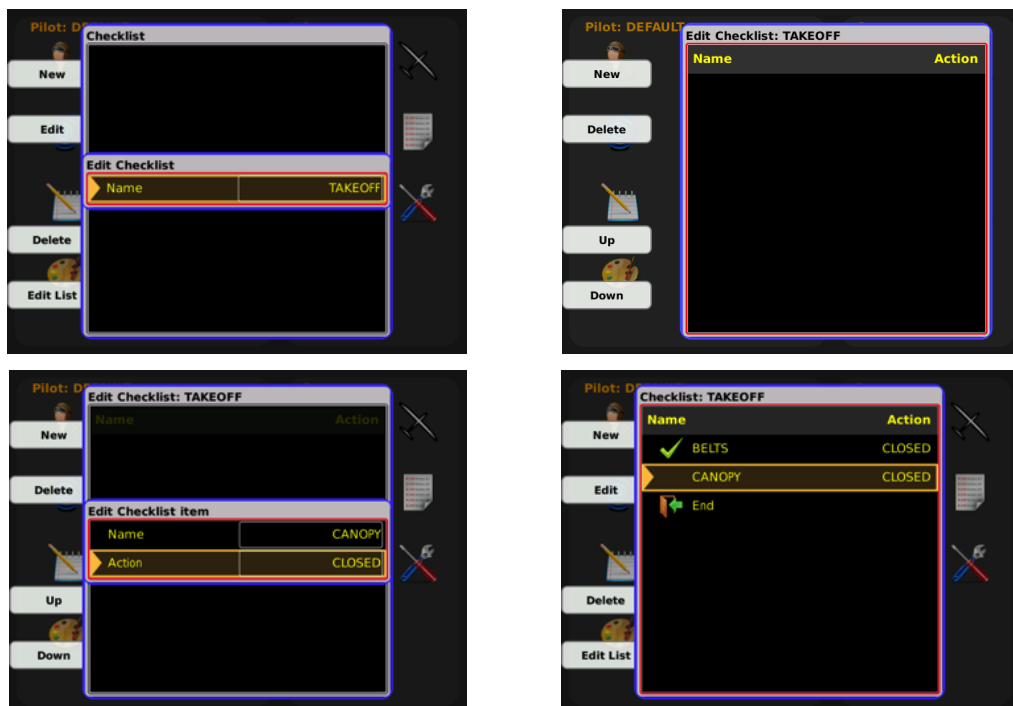

2.2.4 Notepad

In the Notepad menu you can prepare your own .txt file with whatever you might find useful. You can prepare checklists, notes, input frequencies etc...

File .txt can be uploaded with the USB stick by pressing the screen button LOAD (button SELECT/NEAR). Notes can be also written directly in Zeus by using Zoom and Volume knob.

- Screen button MODE is to change between uppercase letters, lowercase letters, numbers, symbols, navigate etc...
- Using NAVIGATE means that you can move at the text by using both rotary switches. Characters can be deleted by pressing the Volume button. To confirm the written text, you should press mode, change to symbols, find enter symbol and then confirm it by Zoom press.
- Screen button METHOD is to change between replace and insert characters into written text.
- Copy to USB is to copy your current note to USB stick and the file will appear on the stick in .txt format.
- Load is to upload .txt file from USB stick.
- Save & Exit – it will save the current notes and also exit to setup menu.

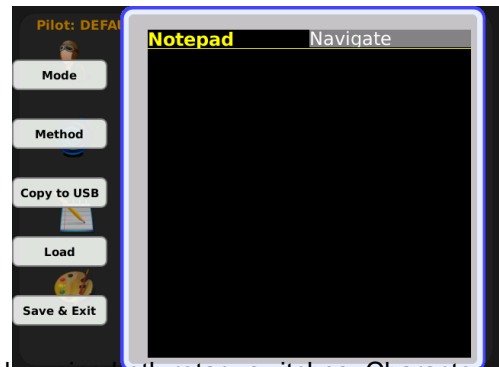

2.2.5 Transfer



The only solution to transfer data to LX Zeus and vice versa is via USB stick. One stick is also part of delivery. The stick that comes with the unit is already prepared. After selecting the item of interest (press on Zoom) the procedure will start.

The transfer procedure:

- Insert USB stick
- Press SETUP button
- Select Transfer
- Press Zoom
- Select what you want to transfer (example airfields), and press Zoom
- Select “transfer file from USB” and press Zoom
- Example: all .af files stored on USB stick will be shown
- Select **file of interest** and press on Zoom
- Transfer will follow and you will receive a window and a **green check**
- Go to **Select**, press Zoom and select the file
- The file is now activated (green check at select row)

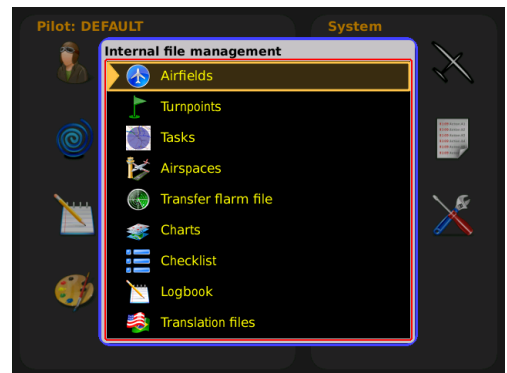

How to delete files (APT, TP, AS):

If there are some files stored in LX Zeus memory which are not actual, they can be removed using **Delete internal files** command. The command is executable for Airports, Turn points and Airspace.



2.2.5.1 Transfer of Airport data

LX Zeus is capable to accept airport data in LX Navigation format (.af). The data is available on www.lxnavigation.com. The database is free and no code is required. The airport files include regular airport data of one continent.

2.2.5.2 Transfer of Turn Point data

The turn point data should be included in a file with extension .cup.

LX Zeus can store nearly an **unlimited number of .cup files** (with 2000 TPs in a file).

Three files of TP can be active at the same time. Turn points of all three files will be available for navigation without any limitations.

Important!

Only one .af file can be active at the same time, so **activate** the file after transfer, after using of **Select** function. A green check means active file.

NOTE

The first TP file is also a so called TASK file, which means, if you want to import tasks from file, then you have to select your file at **TP/Task file**.



2.2.5.2.1 Transfer of Tasks

Task can be uploaded to the Zeus system via USB key. If you wish to transfer a specific task do as follows:

- **Export:**
 - Insert USB stick
 - Press tsk button and select Save to USB (this will save the task in .cup format)
 - Remove USB stick
- **Import:**
 - Insert USB stick
 - Press setup and go to transfer
 - Go to turnpoints
 - Go to transfer file from USB
 - Select the desirable task
 - Go to the TP/Task file window and activate the desirable task.



If you wish to transfer all tasks do as follows:

- **Export:**
 - Insert USB stick
 - Press setup and go to transfer
 - Go to task
 - Select Save tasks to USB (this will save all the tasks as one file in .tsk format)
 - Remove USB
- **Import**
 - Insert USB
 - Press setup and go to transfer

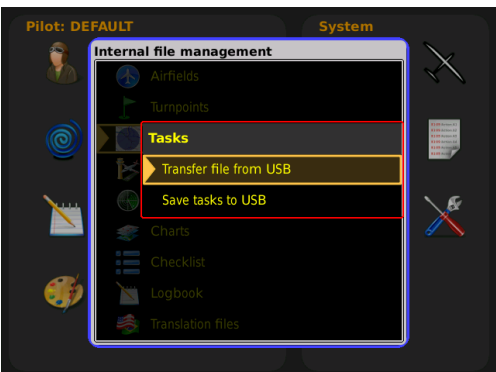

- Go to task
- Select Transfer file from USB

This is valid only for TASKs made on Zeus, tasks done on Seeyou or Strepla have to be uploaded at TP (TP/Task file).

2.2.5.3 Transfer of Airspace files

Use Airspace option of Transfer menu. The files should be in **.cub** format. The actual airspace data are available for free on www.lxnavigation.com. The airspace files normally cover the whole continent.

At the same time, **3 airspace** sections can be active. Loading of airspace files created for events is also possible.

Airspace character length can be maximum 11 characters + **.CUB**.



2.2.5.4 Transfer of Flarm net files

Files with extension **.fln** include Flarm customized IDs. That makes it possible to identify gliders in the vicinity with their original IDs (usual competition numbers). The file is available on <http://www.flarmnet.org>

2.2.5.5 Transfer Charts

ICAO charts can also be used on the Zeus. The ICAO charts should be ordered and purchased from LX Navigation. The file for the charts has to be **.ras** format. Charts will be activated after importing a license file, which you will receive from LX Navigation after payment. The license file should be transferred via the USB stick. At row: view installed charts you will see if your file is licensed.

ICAO charts are made by the Deutsche Flugsicherung. This is the reason that charts have are not free.

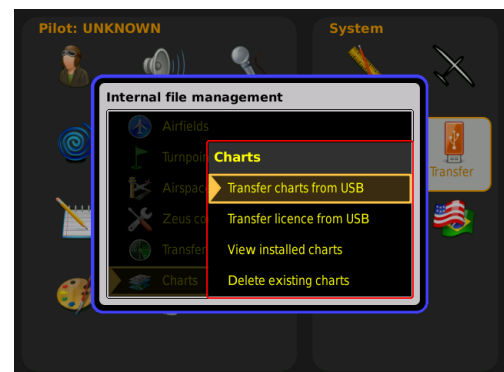

2.2.5.6 Transfer Checklist

Checklist file can be done on personal computer. File must be written in notepad (.txt format). File can be uploaded into LX Zeus system under this menu.

2.2.5.7 Logbook transfer

Flight file can be transferred from Logbook under Statistics or from this menu.

2.2.5.8 Translation files transfer

File can be translated via special software from LX Navigation (ask for it). Once a file is completed it can be transferred into LX Zeus in this menu.

2.2.6 Service



The menu is mainly used for maintenance except:

- Compass calibration
- Level adjustment by units with AHRS
- Detected hardware

With admin password you can set your Zeus back to factory settings with the password 46486. This will also delete all flights from Colibri II.

Useful passwords:

- Factory reset 46486
- Grab image 315
- Delete all flights 99999
- AHRS disable 2478
- Voltage offset 8658
- Screen rotate 9109

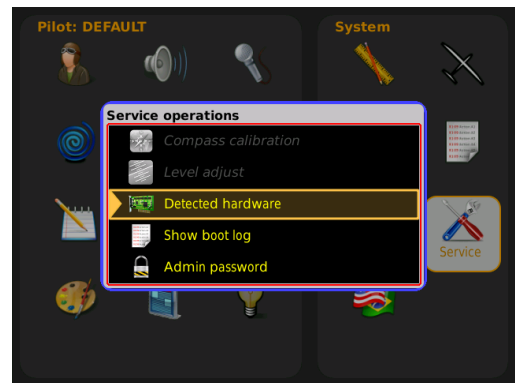

Factory reset WARNING!

All files (TP, AS, APT) will be deactivated and also pilots will be set to UNKNOWN – all pilot's settings will go back to factory settings (save your settings to the USB stick at SETUP MENU/PILOT – save user

2.2.6.1 Screen rotation

Screen can be rotated after inserting a correct password. When a password is entered a reboot of the unit is needed.

Password:

- 9109

2.2.6.2 Compass calibration

Compass module has to be connected to the main unit (in case of double seater, connect to first seat) on 485 bus. Install a module horizontally without any pitch, after that enter to the compass calibration menu. Position your compass to north and press SET, after that you will have to position your compass to all magnetic directions seen on the screen. When you are sure that your compass is positioned to a correct direction you should press SET. When a window with sentence Calibration completed press a screen button SAVE and you will exit back to a setup menu.

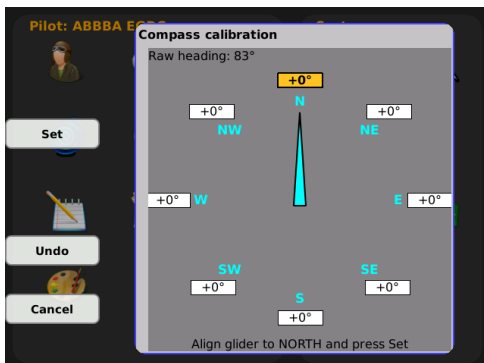

2.2.6.3 AHRS Level adjust (Pitch and Roll)

If the AHRS is not aligned with the glider, then it has to be adjusted.

Changes in pitch are caused by changes of aircraft mass and changes of airspeed. This reference pitch corresponds to one airspeed (indicated airspeed actually) and one aircraft mass. When the glider flies faster or slower, or if the glider is heavier or lighter, then the pitch angle deviates from the reference.

Adjustment procedure is:

- The internal reference level of Zeus instrument is most likely to be different. So you need to adjust it. On the ground, put your aircraft in the position, which you think that matches the position for the reference airspeed. (Do not worry, if this is slightly wrong.) Adjust the Zeus to this level after press on button....
- Make a test flight with your aircraft. Aircraft should be as close to the reference mass as possible. Fly at the reference airspeed and observe the pitch indicated by Zeus. Record this pitch on paper. This observed pitch is the error, which needs to be corrected.
- Repeat the Zeus level adjustment, but now put your airplane in such position (lift or lower nose or tail wheel), that pitch on Zeus indicates the same angle as you have observed during your previous flight. Be careful, to keep wings level. This is now your reference position.
- Keep this position of aircraft (do not move it) and adjust Zeus to be perfectly levelled.

Instrument procedure:

- Go to SETUP / SERVICE / Level adjust
- When the glider is in position to be calibrated press on screen button **adjust** (VARIO/FLARM)
- Wait until status bar reach 100 %
- A significant message SUCCESS will appear
- If you are satisfied with new settings, then press screen button **save** (STAT/EVENT)
- A message Parameters saved will appear



AHRS Calibration		
Airplane axis	Current	New
Roll	-1.9°	
Pitch	1.5°	

AHRS Calibration		
Airplane axis	Current	New
Roll	0.2°	-1.5°
Pitch	-0.2°	1.6°
Adjusting	89%	

Success
The adjustment is complete. Please verify the results

Parameters saved
Adjusted parameters saved to memory

2.2.6.4 Disable AHRS

If you wish to disable AHRS simply do as follows:

- Push on zoom rotary switch
- Go to setup
- Go to Admin password
- Enter password 2478 and confirm with push on zoom rotary switch
- A disable AIRU window will open, there you can:
 - Choose a **time period** (in days) for how long you wish to disable AHRS
 - **Disable AIRU** (AHRS), period



2.2.6.5 Detected hardware

User can check which hardware is connected (recognized) at LX Zeus system.

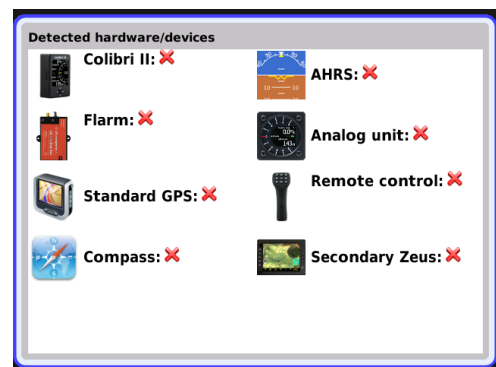

2.2.7 Locale



Here UTC offset to get local time, date format, time format and Position format and language can be adapted to local preferences. A restart is needed for applying this settings.



3 Update procedure

Lx Zeus software is constantly being upgraded. Please contact your local dealer for the latest upgrade.

Upgrade procedure is very simple and can be done by User. Do as follows:

- Put upgrade file on USB
- Insert USB stick into Zeus
- Turn Zeus off and on again
- Hold Vario/flarm button till a window opens
- Select upgrade with a push on zoom rotary switch
- Find the update on your USB stick
- Select the file with a push on zoom rotary switch
- Wait for installation
- In case of Double seater configuration you might be asked if this is FIRST or SECOND seat (confirm correct one)

4 Navigation modes

LX Zeus offers three modes for navigation. These modes are:

- **APT**: navigation to Airports which are stored in APT memory
- **TP**: navigation to turn points (TP)
- **TSK**: task navigation after a task has been entered

Any of the three modes are selectable after sequenced pressing on **A-P-T** push button.

4.1 APT mode (navigation to airports)

LX Zeus is capable to store more airport data files in **.af** format (LX Navigation airport format). At the same time only one file can be active. Selection of the file of interest should be carried out in Setup/Transfer section Airfields.

APT mode consists of three navigation pages (1st is map navigation page, 2nd is subpage with information about selected airport and glide path, 3rd is a map and a 3D view (if not selected then a vertical profile). Any of them is directly selectable by **SUBP** button.

Note: the third subpage (3D terrain) can be disabled (see Setup User interface).

Airports are marked with a symbol (filled black line means airport with asphalt, a line without fill is a grass runway):



The RWY orientation matches the real situation. Extended Airport data are available in the lower section of the second navigation page. After pressing **1-4** button the supplemental information page in form of a vertical profile will open.

4.2 How to select an airport?

Airport selection is active from any mode of operation and also from any subpage. Use press on **Select** button (short press) and select menu will open. Use screen button **APT** by short press at **TSK/MOVE** and selection dialogue will start.



Now scroll with a **Zoom** knob to select a filter such as: **Country, Name, Distance Track or Arrival altitude** to reduce number of offered Airports. If you use filter **sort by distance**, then it is not possible to use a name filter; only country filter is then possible. After the airport of interest is found confirm the choice with short press on Zoom. The APT screen will open with track to destination.

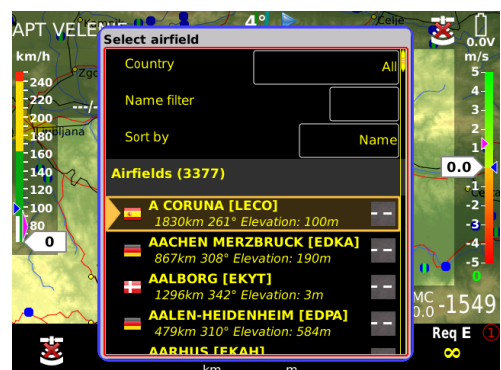

Note!
When using **Name** filter, input first letters of the airport name. Use **Zoom** to scroll and press for confirmation. You don't need to input all characters, just first two or three and after that you can go on by pressing **Zoom**. Input of more characters reduces the number of possible airports.

4.2.1 APT selection from NEAR function

LX Zeus also offers **NEAR** function. After activation, which can be done by a long press on **SELECT/NEAR** button, nearest **Landable points/marker** will be offered. The list includes airports from the Airport database, turn points that are declared as landable and Marker.

Note!
Selection is limited to 200 nearest points



4.3 Navigation in APT / TP or TSK mode

There are three navigation pages possible (APT, TP or TASK) and also 2 subpages are possible all selectable by **SUBP** button.

4.3.1 Sort by filter

Every turn point can be selected by using the following filters:

- Name (alphabetical sorted from number-A-Z)
- Distance (closest TP will be shown as the first)
- Track (TPs -30 to +30 degrees from current track will be shown)
- Arrival Altitude

4.3.2 Main graphic navigation page



The bottom row consists of **NAV BOXes**. Bottom row variants are selectable by 1-4 push button. Any NAV BOX content is custom programmable after using a very simple procedure.

Editing NAV BOXes:

- Long press Zoom (**orange frame will appear**)
- Move orange frame by rotating zoom to free space, or replace current NAV BOX by short press on Zoom
- Select the NAV BOX you want with rotating zoom and confirm it by Zoom press
- If the row is full, press 1-4 push button and add new NAV BOX with the same procedure

4.3.3 Second navigation page (subpage)

Second navigation page is divided into two sections; the upper section consists of a vertical profile. The vertical profile will show you the terrain, glide path distance, Airspaces (yellow and red), selected TP/APT and a cone.

The cone depends on the MacCready setting. The lower line is a MC setting 0 and upper line is your currently set MC. If the glider icon is between upper and lower line it means that you are still below glide path for your set MC, but you will still reach your destination with a lower MC setting. If the glider is below the lower line you are too low and you won't reach your destination even on MC 0.

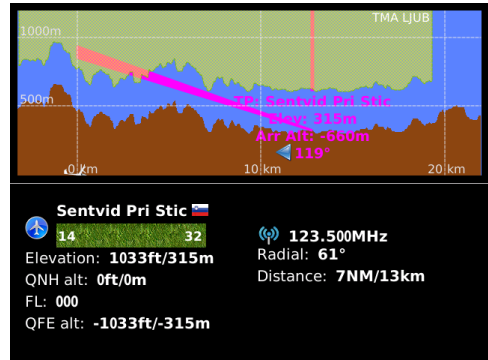

The lower section shows APT / TP data such as:

- Grass or asphalt runway with directions
- Elevation
- QNH alt
- Flight level
- QFE alt
- Frequency of the APT
- Your current radial
- Your current distance from selected APT / TP

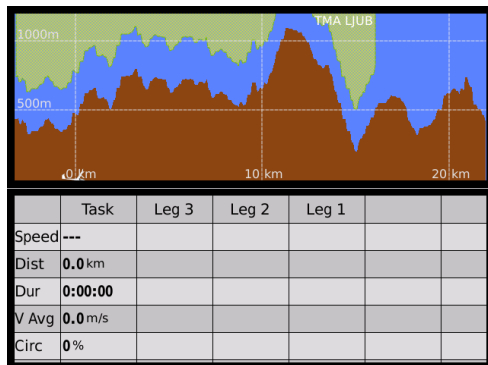

At TSK the lower section is a circling log page, wind profile page and a statistics page with:

- Legs
- Speed
- Distance flown
- Duration
- Vario average
- Circling on task in percentage

4.3.4 Third navigation page (2nd subpage)

The third navigation page shows terrain data that is split to a map and an AHRS (artificial horizon). If the AHRS is not purchased as a part of the Zeus system, then it is a vertical profile.

Note!

This 3rd page can be disabled after command is executed in Setup/User Interface.

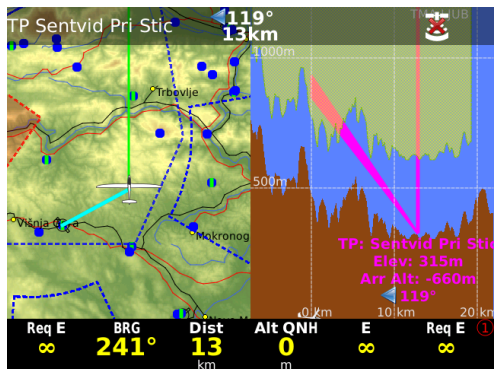

4.3.5 Use of Remote Stick in APT

All basic APT functions including fast selection of APT can be done by using the LX Remote Stick.



Zoom IN/OUT:

Use buttons Minus and Plus on the Remote Stick

Select ATP screen:

Use APT button and press it until you will have the indication on the top in left corner APT

Select second page:

Use SUB and you will the second or third page of the screen

Change information at second page between APT info and Terrain:

Use 1-4 button, you can also Zoom In/out with Minus / Plus

Select APT:

- Press X button
- Use MINUS to go to Country, Name or Sort by distance filter
- Use Check/confirmation button to select your filter (*Example Name filter: press Check, press Plus to change the character and press confirmation, go down with Plus and select your APT with Check button*)

Change MC:

- Press MC
- Press Minus / Plus button
- Press X to escape

4.4 Turn point mode

The structure of the mode is similar to APT, the only important difference is, that the navigation is towards turn points that are included in turn point files. The turn point files (.cup) should be uploaded by USB stick. See **Setup/Transfer** for details. Practically an unlimited number of .cup files can be uploaded. Turn points can have different **attributes** and therefore also symbols that represent that turn points are different.



Turn point



TP as grass airfield

TP mode consists of three navigation pages (1st is map navigation page, 2nd is subpage with information about selected airport and glide path, 3rd is a map and an AHRS – if no AHRS, then vertical profile. Any of them is directly selectable by **SUBP** button.

Note: the third subpage can be disabled (see Setup User interface).

Extended TP data are available in the lower section of the second navigation page. The upper part of the display (2nd –subpage) is vertical profile.

To get the screen buttons for TP options, Zoom should be pressed at TP screen (not at APT, TSK).

Note!

Up to **three turn point** files can be active at the same time. The activation should be provided in Setup/Transfer. Turn points included in all three files will be available for navigation. The first is TP/TSK file, which will import also tasks.

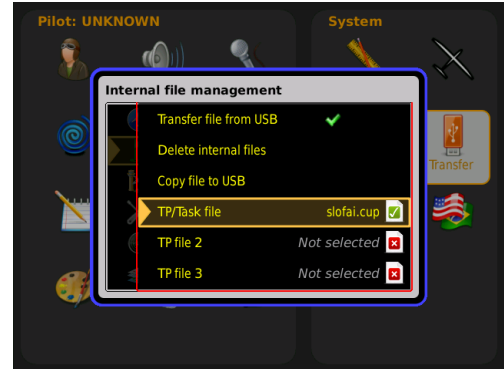

4.4.1.1 Edit TP

Press Zoom button, select screen button **Edit TP (press TSK/MOVE push button)**, and a new window Edit turn point will open.

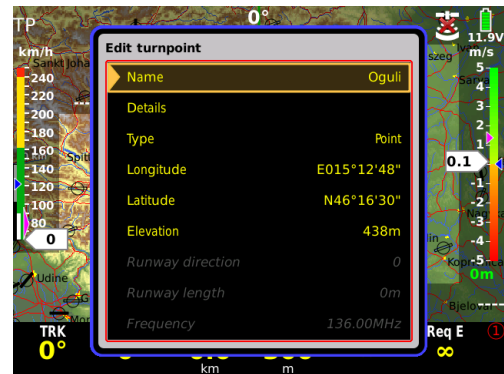

4.4.1.2 Creation of User Turn points

User turn points are turn points that are created by the pilot after using commands of LX Zeus. Such turn points are marked with **U** and a **PILOT** icon in front of its name.



4.4.1.2.1 Auto TP

If you select Auto TP, a user TP will be created, with the current position and the current time as it's name. If you wish to edit an Auto created TP use the Edit TP function.

4.4.1.2.2 Creation of a Turn point by hand

Press on **Zoom** button and following menu with screen buttons will open. Run **Add TP** after pressing on **STAT/EVENT** push button.

Following should be inputted:

- Name
- Details (not obligatory)
- Type (grass, field, tower...)
- Longitude, Latitude

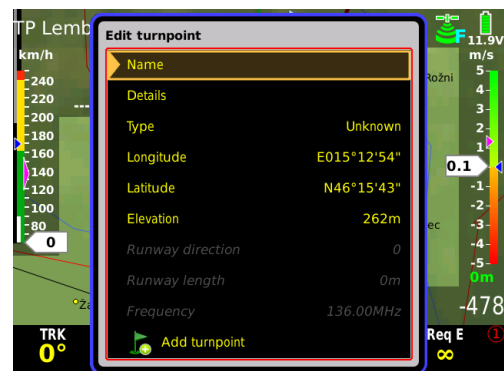

- Elevation

Next three inputs may not be highlighted due to the type or turn point you are adding. **Finish** the process with **Add turn point**.

4.4.1.3 Add Marker

The philosophy of a marker is to mark a position that you want to have as your backup.

For example, you are flying towards non-landable area and you see the last landable field below you. At this landable field position you can drop a marker. You will be able to navigate to your marker, which you can select at NEAR/TP, or select TP.

You can have only one marker at once. If you will drop another marker, the first one will be replaced. The marker can be also changed to TP via EDIT TP. It can be also deleted via DELETE TP.

4.4.1.4 Delete TP

Only user created turn points and marker can be deleted. To delete TP you should press Zoom, select screen button DELETE TP and a new window will open. Select the TP by rotating the Zoom knob and confirm it with short press.

4.4.1.5 Send TP

If you select Send TP, you can send the current selected TP to the second seat (all info about the TP will be send).

4.4.2 Selection of a Turn Point

The selection process is similar to APT. Use **SELECT** button to start the process and press at screen button **TP**. Country, Name and sort by distance, track, arrival altitude filters will expedite selection. Turn points are visualized by symbols.

Important!

Turn points without **country designators** are selectable only when using **Country "All"** option. This is also valid for user turn points. It is advised to manually check and correct your files before uploading them to Zeus, to ensure maximum software potential.

Note!

Type option offers plenty turn point designators. The designator defines the symbol that will appear on the display. Landable points will also be listed in NEAR function.

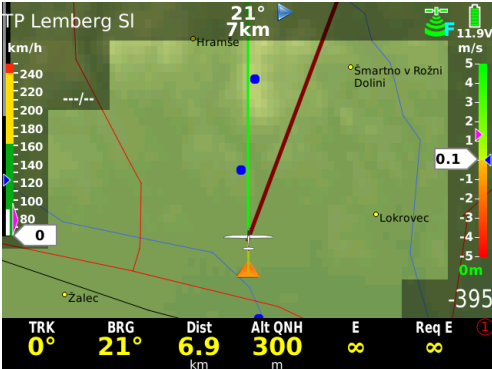

4.4.2.1 Selection from Near

LX Zeus Near function offers Turn point selection based on distance. Respected that there is also Country filter active, use **All** if you want to get all turn points listed.

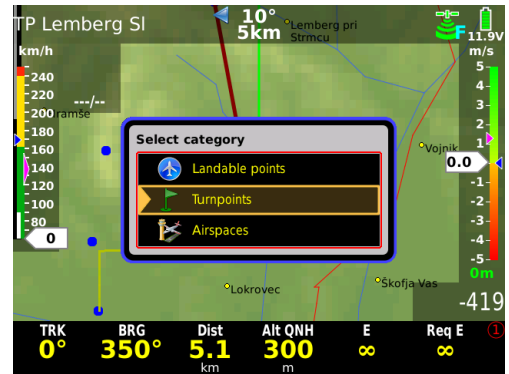

4.4.3 Navigation to a Turn Point

Navigation towards a turn point doesn't differ to navigation to an airport, so refer 3.3 for details.

4.4.3.1 Use of Remote stick

Use of Remote Stick is the same as for the APT, read more at 3.3.5

4.5 Task Mode

Task is a complex process that guides the pilot around the turn points of the task. Each task consists of turn points, start point and the finish point. Additionally take-off and landing can put in, but those points don't have any influence on task execution.

4.5.1 Task organization

Zeus has storing capacity for 101 tasks. 50 tasks can be imported in one **.cup** file and such tasks are called **imported (IMP)**, next 50 can be created by **user** in LX Zeus (by hand) and those tasks are called **User (USR)**. After creating or selecting TSK, the TSK is automatically declared.

Note!

Tasks that you want to upload to Zeus should be a part of a **.cup** file and should be selected in **SETUP/TRANSFER** as **TP/TSK** file. **It is very important that you name the task, otherwise the Zeus won't recognize it.**

4.5.1.1 Task declaration

Declaring the task is an automatic process. After a task is constructed and exit is pressed (Volume knob) a very clear message on the LX ZEUS screen appears: **TASK DECLARED!** This means that LX ZEUS will start sending the declaration data to loggers. The declaration is sent to Colibri II automatically – with all TPs, edited zones, limitations etc... Colibri II has the priority and will receive the data first. After this, declaration data will be sent to FLARM. The process will take about 30 seconds. After the process is finished all LED lights will switch off on the FLARM display and the red **POWER** light will start blinking. This means that the process of sending task declaration to FLARM is finished.

4.5.2 Task selection

To select task from LX Zeus active task store use **Select** button and select screen button **TSK**. Use Zoom knob to select task of interest. During the selection process all task relevant data will be present. Confirm selected task by pressing Zoom knob and you will get another window with task details. Exit by pressing on Volume twice, or wait until the window will escape automatically (if you have auto close inactivity timeout set).





User task



Imported task

4.5.3 Task creation by “hand”

To create new task you should press push button **TSK/MOVE (short press)** or short press on **Zoom**. The task can be created by hand after using of **NEW** or **EDIT** screen buttons. Edit will make it possible to edit an existing task and New will offer creation of a new task. Both tasks will be saved in USER (if you edit an IMP task, it will automatically change from IMP to USR).

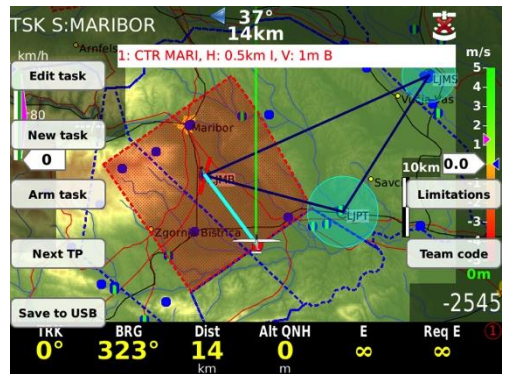

The procedure:

- Press TSK/MOVE button
- Select screen button NEW (TSK/MOVE) or EDIT Task (VARIO/FLARM).
- If you have an AAT task, then add time by press on Zoom and rotate Zoom/Volume, terminate by pressing Zoom.
- Rotate zoom to add Task name – press Zoom and add name.
- Rotate zoom to TPs – press zoom and select/insert TP or APT. Only TPs can be deleted (start and finish not).
- If you agree with the task then press Volume to confirm – you will get the message that the task is declared.

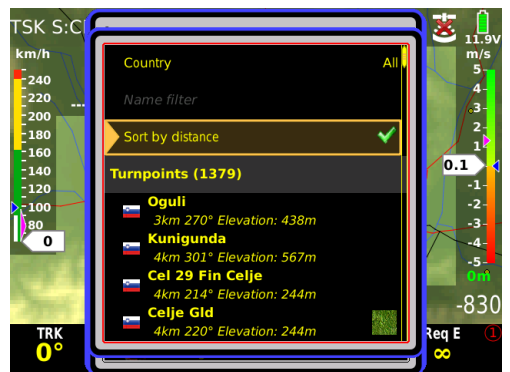

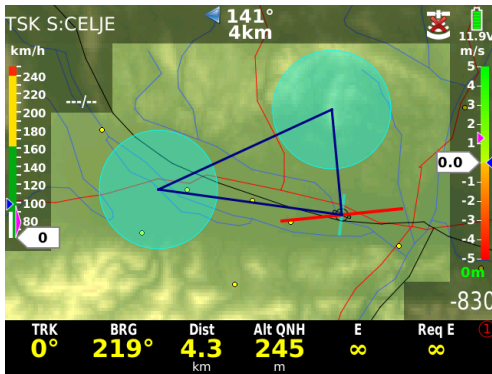

Task Zoom

4.5.3.1 Create and Edit Zones

ZONE function makes it possible to create any known geometry for turn points, start and finish. The zone can be edited by selecting **TSK EDIT/ select TP / ZONE**. The creation consists of input of sector angles radius and orientation.

After a press on Next zone or Previous zone buttons the user can change zone settings very quickly without any additional actions.

Note!
The task can also be seen at full ZOOM OUT – you will get the TASK ZOOM function. The task zoom will be active only if on the ground!

Note!
Active zone has a different colour than inactive zone (colours can be adjusted in SETUP / USER INTERFACE / TASK COLOURS)

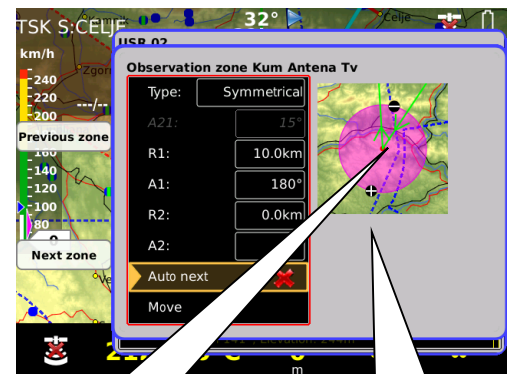

Minimum calculated distance between turn points

Maximum calculated distance between turn points

Auto next input defines change over philosophy over turn point. **AUTO** means automatic change over immediately after sector will be reached. This function is default active as **sector radius is below 10 km (assumed racing task)**. Bigger sectors offer a non automatic change over (assumed AAT task). If **Auto next NO** is active, **MOVE** function (for AAT) will become active and that makes possible to modify the task distance even before flight.

MOVE during active TSK is also possible. Long press on push button **TSK/MOVE** will open a move window. You can move your 'custom turn point' by rotating Zoom and Volume. During move you will see the important information next to your moved TSK (Total distance, Required speed, final glide at MC 0 and selected MC).

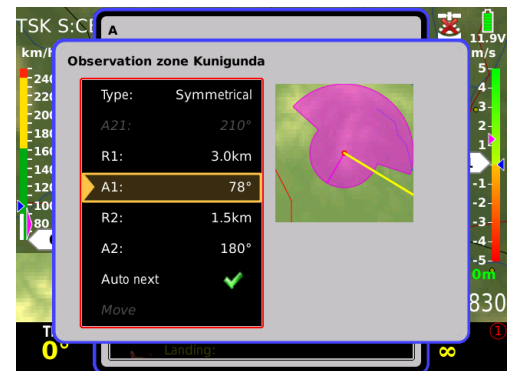

Note!
Default task zones can be adjusted in SETUP / USER INTERFACE. User is able to adjust default start, waypoint and finish zone to make task creation even easier. When a new task will be created these zones will be in use as a default.

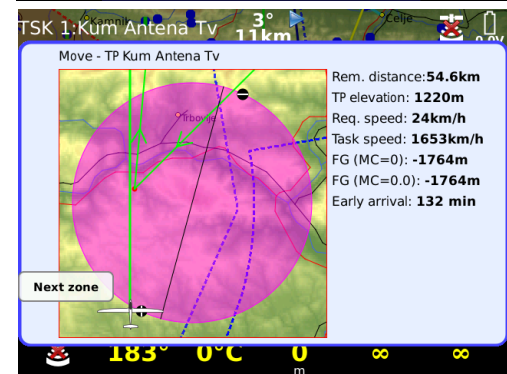

Note!
AAT task – if the sector is bigger than 10 km, than AUTO next won't be active. If the sector is smaller than 10 km, then you have to uncheck MOVE in ZONE menu

4.5.4 Task Start (ARM), Restart, Next TP, Clear, Save, Team Code, Limitations

Automatic and manual starts are possible by using functions ARM and NEXT TP. All functions are available by pressing Zoom or push button **TSK/MOVE**

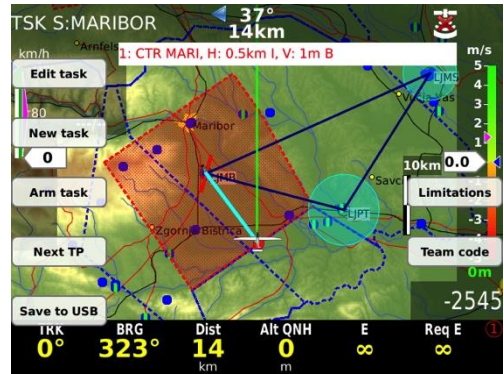

4.5.4.1 Task Start

To start automatically use the ARM command which is offered after a press on TSK button. Arm means that the task will be automatically started after crossing the start line. If you then cross the start line multiple times, the time of the last valid start will be used for statistic calculation. Every next start is also visualised by a green message.



During flight you can also disarm your task. Activation of ARM and also DISARM are clearly shown on the display by the message and an ARMED icon.

If you forget to press ARM and you are already on the task, then you have the second option to press NEXT TP. Next TP command will change over to next TP every time when activated, doesn't matter if the glider is in the sector or not. It will also take your latest starting line crossing time, so that task statistics will be correct.

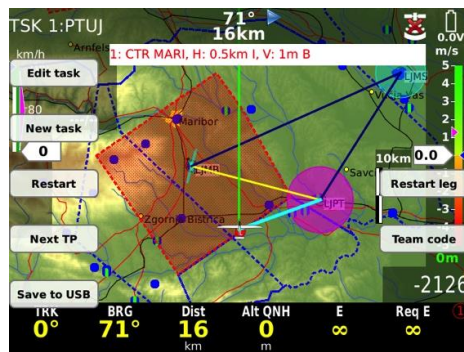

4.5.4.2 Task Restart function

After task has been started (method doesn't matter) a task restart can be executed at any time. Use **Restart** button in the TSK menu. **Restart button** will become active after task starts. After restart all task statistics data will be zeroed and ARM status will become active, which makes it possible to provide next automatic start.

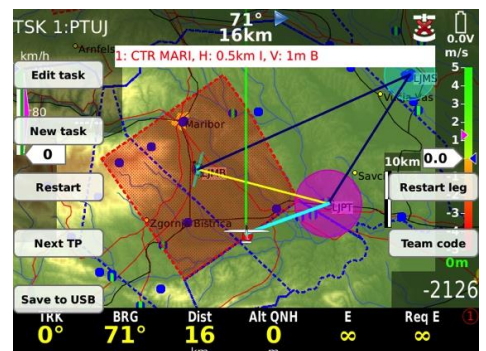
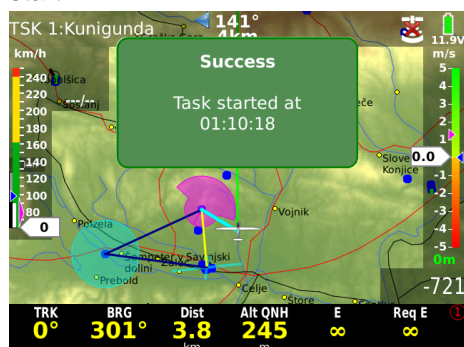

4.5.4.3 Over Turn point

Change over to next turn point may be automatic or manual. Automatic changeover will happen when **Auto next** of individual zone is set to auto. If the zone is not AUTO NEXT, then you will get the message INSIDE zone. If you want to go to next, press TSK/MOVE and press screen button NEXT TP.

Default setting for Auto next:

- R1 below 10 km Auto next active (automatic change over)
- R1 above 10 km manual change over necessary

Type:	Symmetrical	Type:	Symmetrical
A21:	314°	A21:	314°
R1:	7.0km	R1:	10.0km
A1:	180°	A1:	180°
R2:	0.0km	R2:	0.0km
A2:	0°	A2:	0°
Auto next	✓	Auto next	✗
Move		Move	

Note!

Manual changeover is possible exclusively by **Next TP** command. **Next TP** is always active and it will execute changeover to next TP at any time. Activation of this command when you are still out of the sector will degrade statistic data. Solutions: deleting of the TP that will not be rounded, or extending the zone/sector.

4.5.4.4 Saving TSK to USB

LX ZEUS offers the option to save created or edited tasks to USB. A USB stick has to be inserted in the USB port. After creation of a Task, press volume knob to escape and confirm task. After that press TSK button and press SAVE TO USB, which is near to the SETUP/INFO button. The Task will be saved to the USB stick as a .cup file with all the tasks TPs and zones.

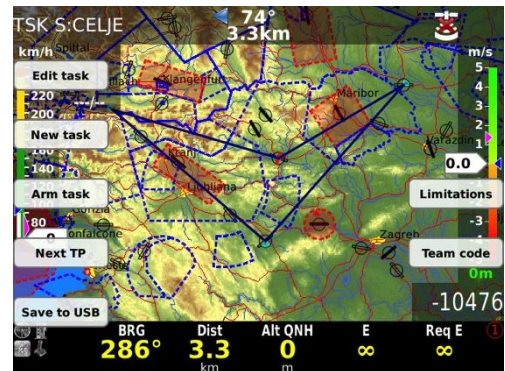

4.5.4.5 Clear TSK

When in the creation or editing menu of a task, the whole task can be erased with two pushes. First press CLEAR TASK, which is near SETUP/INFO button and then press YES to confirm your choice or NO to terminate the process without erasing the task.



4.5.4.6 Team Code

Team code is a feature enabling you to visualize the position of your wingman and keeping it secret. Short pressing TSK button, a TEAM CODE icon is visible on the right side, near the 1-4 button. Press 1-4 button and a menu requiring team code and reference point will appear. To use this feature three NAV BOXes have to be switched on; TEAM CODE, TEAM BEARING and TEAM DISTANCE.

Before take-off, flying partners have to decide which reference point will be chosen. For better indication (more accurate) a reference point which is 50-150 km away from every position in the flight should be chosen (for example the task that is flown should be in the 50-150 km radius of the reference point; if the task is bigger a second reference point should be chosen and entered after passing a certain distance). In flight, when partners are interested about their location, team codes should be exchanged (via radio) which are visible in TEAM CODE NAV BOX. Partners are able to see bearing and distance to each other in the TEAM BEARING and TEAM DISTANCE NAV BOXes.

The feature works on the principal of the polar coordinate system. Baseline condition to be fulfilled is a reference point. When this is chosen, LX ZEUS calculates distance and bearing from reference point to pilot's location and codes it into TEAM CODE. First two characters mean the angle and the last two the radius from the reference point. When this information is given to a partner with the same reference point chosen, LX ZEUS can calculate direct bearing and distance to the other partner. The process works either way between partners.

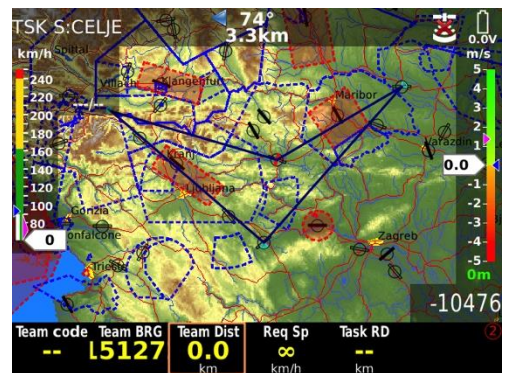
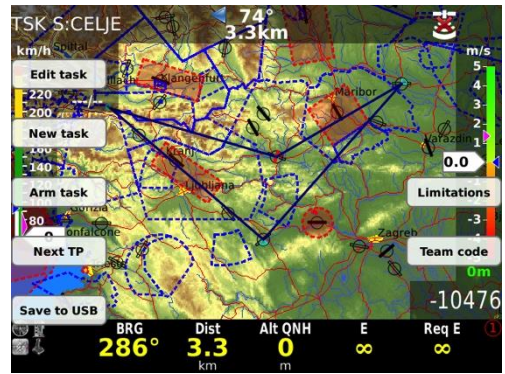

4.5.4.7 Limitations

Here you can put in task start conditions. It is possible to:

- Define **Gate time**
- define **before start**
 - Below altitude
 - Below time
- Define **start conditions**
 - Start altitude
 - Start ground speed

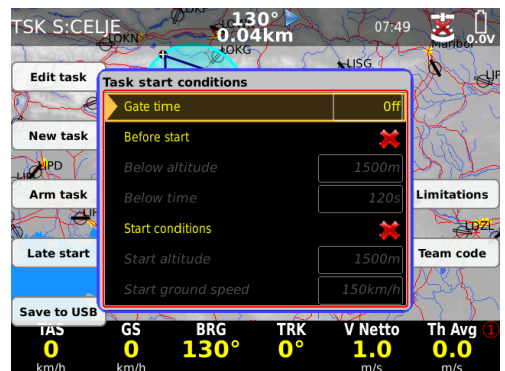

For the explanation of these terms read more under chapter 12.2.4.1 Start Conditions/Limitations

4.5.5 MOVE Function (during flight)

When flying an AAT, big sectors are set and therefore the pilot has to decide where to turn to next point. Function MOVE helps the pilot to find optimal solution. After long press on **TSK/MOVE** button the so called MOVE function will become active. Use Zoom and Volume knobs to move the turn point. All task relevant data that are affected by the move command are shown next to the zone.

During straight flight far from zone the track will appear in the zone in MOVE function. When the glider will be in the zone, the real-time picture (glider with its track) will also be shown in MOVE function.

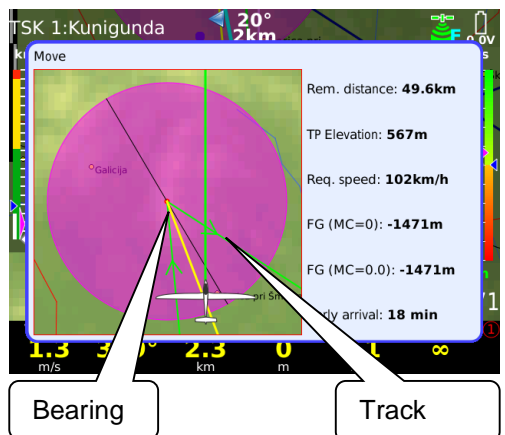

4.5.6 Task Zoom

By rotating zoom knob to the left will show the whole task (task zoom) on the screen. Task zoom will show all turn points (moved and modified) with airspaces. Task zoom is not visible while flying, only on the ground.

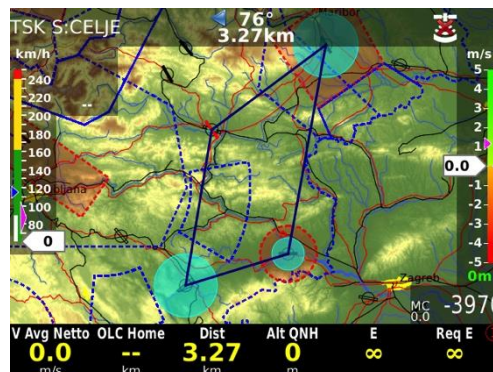

4.5.7 Use of Remote Stick

All basic functions including selection of TSK can be done by using the LX Remote Stick. To select TSK, the TSK screen should be active (upper left corner TSK sign). Press X on the Remote Stick and you will get the window with user and imported tasks. To select use Minus / Plus and confirm with Check symbol. Do the same procedure to change anything on the TSK.

Zoom IN/OUT:

Use buttons Minus and Plus on the Remote Stick

Select TSK screen:

Use APT button and press it until you will have the indication on the top in left corner TSK

Select second page:

Use SUB and you will the second or third page of the screen

Change information at second page between APT info and Terrain:

Use 1-4 button, you can also Zoom In/out with Minus / Plus

Change MC:

- Press MC
- Press Minus / Plus button
- Press X to escape

Select in TP/APT/TSK mode

Press “check” button and windows with different functions will open, depending if you are in TP, APT or TSK mode. One of them will be yellow, which means, that this window is the current chosen one. You can move to a different window with the + or – zoom buttons. To select the chosen window simply click the “check” button again and the next window will open. Manipulation from here on is the same as everywhere else for LX remote.



5 Airspace Management

The airspace used in LX Zeus can be managed by pilot to achieve optimal relation between loading of the display and readability of the display. Too much information will reduce display readability significantly.

5.1 Basic airspace settings

Those settings are available in **SETUP / AIRSPACES**. User can select warnings and appearances regarding to zoom.

5.1.1 Hide airspaces above

The airspace sections which are much higher than actual glider position are not so important, but if disabled will reduce information density of the display significant. Use **Hide airspaces above airplane** to define altitude margin that you still need for a safe flight.

5.1.2 Other setups

Hide above QNH altitude lets you choose above which QNH altitude the airspaces should be hidden.

Horizontal and **vertical distance** warnings can be set also in this section. Zeus will warn a user at predefined distance warning. Default settings are 100m vertically and 2 km horizontally.

Warning timeout at take-off lets you choose how long after takeoff there won't be any airspace warnings.



5.1.3 Define appearance of airspaces regarding zoom

After using of **Show on zoom** function you can define by which zoom the airspace will become visible on the display. Two extreme situations are described with **always** and **never**. Factory default settings are **always**.



5.1.3.1 Warnings

If set disabled (X) the airspace warnings will not appear at all, setting checked (✓) will produce airspace warning information.

Warning box is an indicator of the display, so the pilot is able to move the box and also to customize colours. This can be done at **SETUP / LAYOUT**

Airspace warning information consists of Airspace name, horizontal and vertical distance and is as default positioned in the upper section of the display. The nearest point to enter the airspace becomes visible on the display. As long as the warning isn't critical the text will be blue.

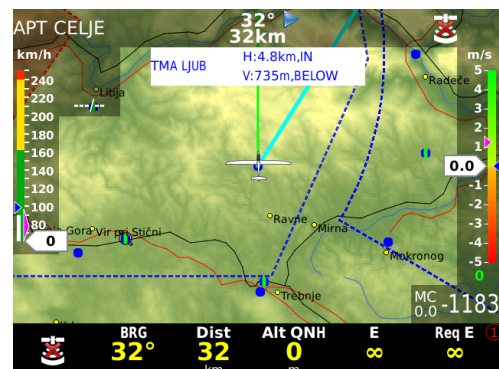

The airspaces can be also seen at the subpage in different colours (yellow and red). You can see vertical profile of airspace with glide path. Airspace is also seen in a second subpage, where the page is split to a map and a vertical profile.

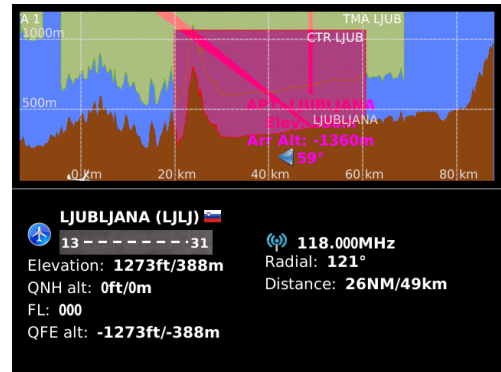

Explanation of airspace warnings

The picture shows that the glider is in the CTR LJUB airspace. It shows that the glider is horizontally 7.4 km INSIDE and vertically 308 m BELOW. The warning is BLUE, because the glider is in fact out of the airspace (below). If the glider is in an airspace warning will be RED and will be written horizontally and vertically IN.

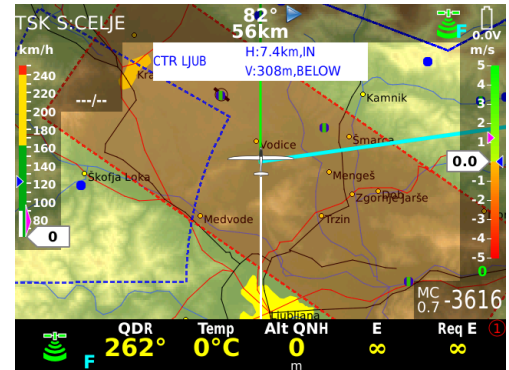

5.1.4 Disabling of airspace sections

In flight airspace warning will appear as it is on the picture on the right. Warning can be easily disabled after a long press on one of the screen buttons.

User can also disable airspace on the ground after a long press on SELECT/NEAR button to engage NEAR function or short press on SELECT and click the screen button AIRSPACES. Airspaces are sorted by distance. In the upper dialogue a name of the airspace is shown, horizontal distance, operating altitude from and to in meters and also as a Flight level.

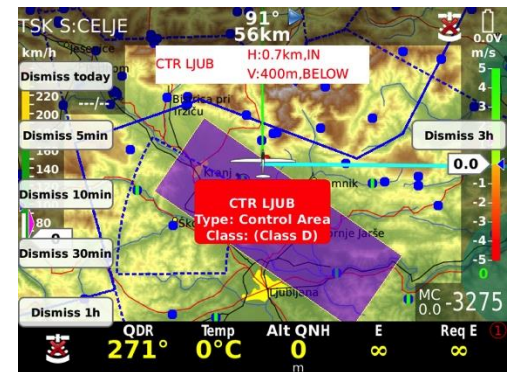

By rotating the Zoom button, each airspace can be selected and shown on a map. By rotating the Volume button a different zoom will appear. After a press on Zoom button or press on screen button EDIT, additional options can be modified such as:

- Airspace type
- Airspace class
- Disable airspace until specified date

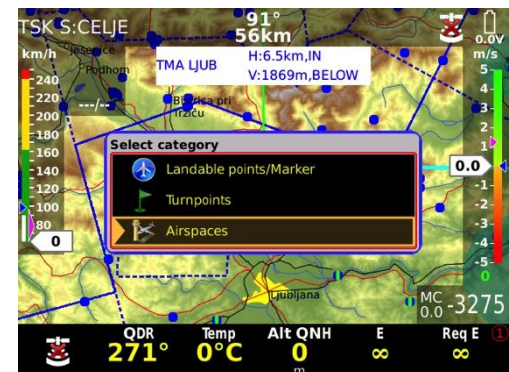

A screen button DISABLED ONLY will show only disabled airspaces, which can be also modified.

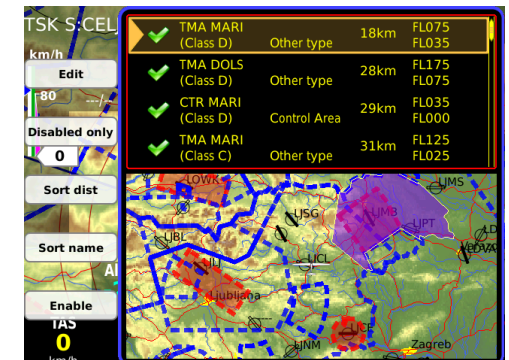

A dialogue to edit airspace after a press on EDIT button

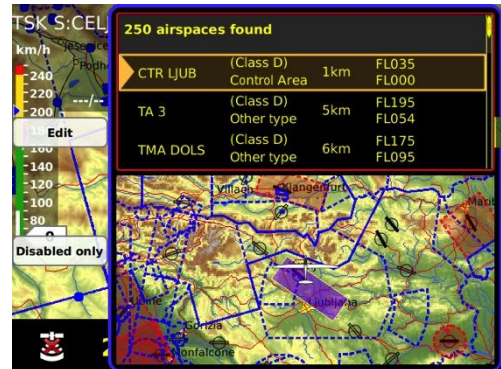
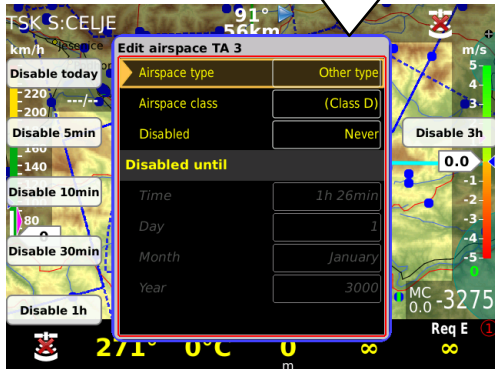

6 GPS signal management

LX Zeus has two inputs for GPS signal which are available on the back of the unit. Both solutions are realized by 6P telephone type connectors which are marked as:

- Colibri II
- Flarm

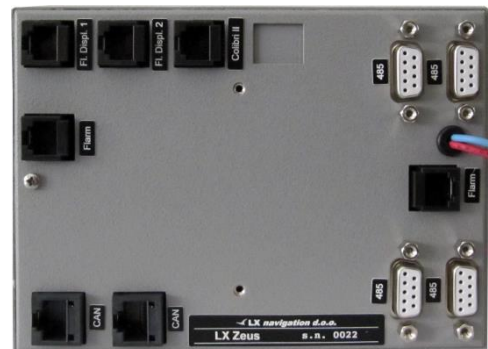

6.1 Colibri II plug

Colibri II plug can be used exclusively to connect Colibri II units. The plug delivers also power (5V) for Colibri II and receives its data directly without any data interface. The communication way is bidirectional. Every unit equipped with Colibri II comes with suitable connection cable (USB mini/ 6P telephone).

Note!
Colibri II is powered from LX ZEUS. Also all the declaration and settings are sent from LX ZEUS to Colibri II, so user doesn't need to do any actions on Colibri II.

6.2 Flarm plug

Flarm marked input makes plug and play solution, to connect any unit that has an IGC standard compatible connector. **The port also delivers 12V.**

Note!
LX Zeus is able to adapt baud rate to any value between 4800 and 38400 automatically, so baud rate of GPS source connected to Flarm input does not matter.

Following units can be connected with the plug and play solution:

- Colibri, LX 20 – 2000, VL, LX Flarm RB, LX Flarm MB, Flarm (Swiss)

6.3 GPS signal for navigation

Both GPS input connectors are wired to LX Zeus microcontroller module that prepares an integral GPS signal for the main computer. So, the computer will be supplied with valid GPS signal as long as one GPS receiver delivers valid data. A symbol that is positioned in the right upper corner of the display shows GPS signal status:

- red GPS BAD
- green GPS OK
- white symbol with ☒ means no GPS data present



7 LX Zeus and Colibri II

Colibri II and LX Zeus build a **compact system** that offers that all commands connected with flight recorder can be sent from Zeus. LX Zeus is master and Colibri II is slave. This organization philosophy makes it possible to install Colibri II in a place where the pilot is not able to provide manipulation and also does not need to see the display. As long as it's a position which ensures good GPS reception. It is absolutely necessary to use Colibri II version 1.90 or higher. Colibri II has also an ENL sensor built IN, so each unit comes with ENL.

7.1 Colibri II power management

Immediately after LX Zeus receives is powered, the Colibri II will automatically switch **ON**, without any pilot interaction. **After landing** Colibri II will **remain ON**, as long as Zeus will be powered. When Zeus will be switched off, Colibri II will remain on for a limited time and will switch off after approximately 5 minutes (some beeps from Colibri II will be heard as a signal, which means that Colibri II will switch off). Colibri II is charged permanently from Zeus and this ensures that the Colibri II battery will be always full. When for some reason battery power is lost on Zeus during flight, Colibri II will continue to record the flight for up to 15 more hours.

7.2 Colibri II - Zeus interaction

After connection between Colibri II and LX Zeus is established both units start to communicate using a special LX protocol where the baud rate is 115 000 baud per second. The connection is established fully automatic without pilot interaction.

7.2.1 Commands and declaration transfer to Colibri II

After power ON and connection between both units is established following data is sent to Colibri II:

- pilot data: immediately after **pilot name** selection during booting (also pilot 2 name in case of a twin)
- **recording interval** which is set in Zeus at the moment
- **other data** connected with recording (Event...)
- data of actual **selected task** (the task will become **declared**)

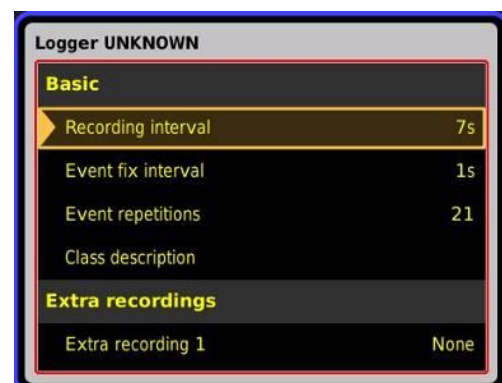

Important!

Any change on task, doesn't matter USER or IMPORTED will immediately update Colibri II task. As long as on ground, the **new data** will be written also into declaration of Colibri II flight recorder. The same will happen with the pilot. After take-off the task update will also work, but the declaration in the flight recorder will remain unchanged (IGC rule).

Password 46486:
Password 46486 will also delete all flights from Colibri II

Event command will be sent to Colibri II immediately after **EVENT** command will be executed on Zeus. Event command can be used also from a second seat unit.

8 LX Zeus and Flarm

Flarm should be connected to FLARM marked plug of the LX Zeus. Flarm will also receive power via that plug. If Flarm is also connected to the aircraft power network via its own power input wires, a short break circuit problem does not occur due to a built in diode. This separates both power supplies. Up to two Flarm external displays can be connected to the plugs marked as Flarm external display. SD card slot on LX Zeus front is directly connected to Flarm SD interface (valid for RB), without Zeus interaction.

The SD card may be used for:

- Flarm firmware update (Red box or Mini box)
- Downloading of flights stored in Flarm (Red box or Mini box)

On the backside of LX Zeus there is enough space to install LX Red box as an integral part of the system. All connections are plug and play. Non-integral solutions can of course also be used.



Original Flarm (Swiss) can be also used. Zeus will show objects from Flarm on its display and will also provide power for Flarm. Declaration will be also sent from Zeus to Original Flarm. SD card slot cannot be used for Original Flarms.

NOTE

In case of REDBOX, there must be only 1 SD card inserted at once; either in Zeus SD card reader or in Redbox unit, but not in both at once

GPS signal priority

If there are both units (Colibri II and Flarm) connected to Zeus, Zeus will take a better GPS signal reception.

8.1 Flarm external displays

LX Zeus HW makes it possible to connect up to two Flarm external displays. Both plugs are controlled from Flarm directly without any Zeus influence. The Zeus system also provides 3V power for Flarm displays.

8.2 Task declaration into Flarm

In case of an IGC approved version of Flarm, which is connected to Zeus Flarm port, an automatic declaration process is executed. The process is identical as with Colibri II, that means the actual task and pilot data will be sent also towards Flarm. In general the task which was active (selected) in TSK menu will be written as declared.

The process will take about 30 seconds. After the process is finished all LED lights will switch off on the FLARM display and the red POWER light will start blinking. This means that the process of sending task declaration to FLARM is finished.

Declaration warning!

SD card should be inserted into SD slot without any CONFIG (.cfg) file on the card! If .cfg is on the card, then this file will have priority and the declaration will be wrong. There will be .cfg declaration instead of Zeus declaration

Important!

Logger settings (recording interval...) will not be sent to Flarm, use SD or Flarm Tool (see: www.lxnavigation.com – support / manuals: LX Flarm update instructions.

8.3 Transferring files from Flarm

Transfer of files from FLARM to Micro SD card is a very easy process. Micro SD card has to be inserted into Micro SD port, which is found on LX ZEUS front panel! (In case of red box flarm, it is also possible to insert the card directly into the flarm unit). After the flight is finished wait for three minutes, then turn LX ZEUS OFF and ON again. After switching on, a red POWER LED light on the FLARM display blinking can be seen, all other LED lights are off. This means that all the flights that were not already on the Micro SD card are transferring themselves. After the red POWER LED light stops blinking, remove the Micro SD card and all the flight are there.

If the micro SD card has not been used for a while, FLARM will automatically transfer all flights that are not already on the Micro SD card, from its internal memory to the micro SD card. If there are a lot of flights to transfer, the process may take up to 20 minutes! Flarm will always store maximum 20 flights, so, if a 21st flight is recorded, then the oldest flight will be removed automatically.

Note!

The micro SD port is an extension of the FLARM system and settings cannot be changed via LX ZEUS!

8.4 Flarm Red Box / Mini Box update

Flarm Red Box and Mini Box can be updated via SD card or PC by using Flarm Tool software. Read update procedure at: www.lxnavigation.com – section SUPPORT / MANUALS: LX Flarm update instructions.

8.5 Flarm PIN OUT

Bellow you can find information about pin out on Flarm connector – it is standard IGC connector.

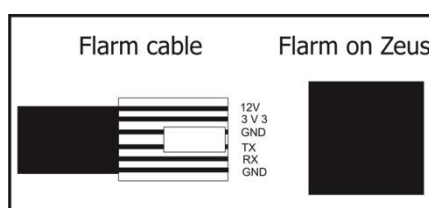

9 LX ZEUS and Garrecht

Garrecht units can be simply connected to LX ZEUS without any software requirements. Declaration to flarm will be sent directly from LX Zeus. Updating Garrecht units is not possible via LX Zeus. Connection schematics are shown below.

9.1 LX ZEUS and Garrecht TRX-1090 ADSB / TRX-2000

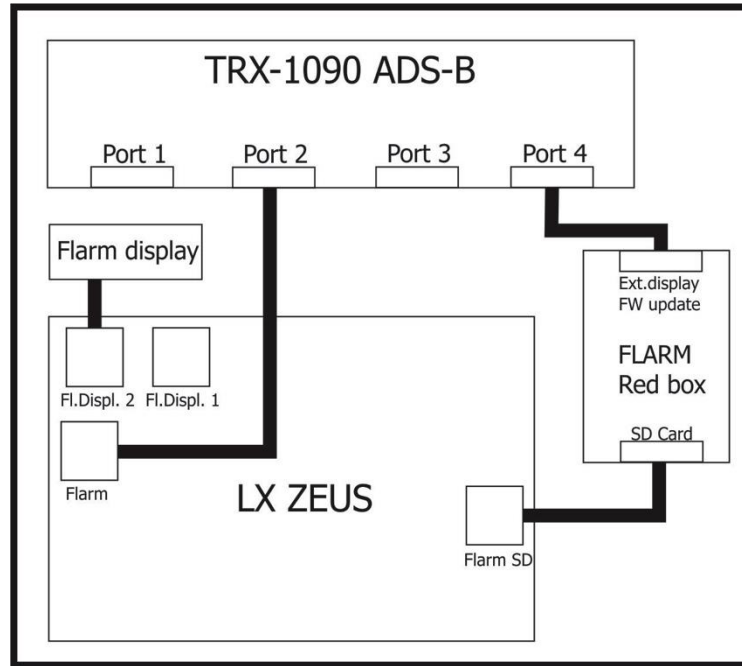

9.2 LX ZEUS and Garrecht TRX-1500

A special cable is needed for that connection. This cable can be ordered at LX Navigation under following code: LX-TRX1500.

10 Remote Control

LX Zeus can be also operated by remote control stick. The stick is a standard LX Navigation product which differs from sticks used by LX 7000/7007 series only in labelling. Therefore the upgrade of an existing stick is very easy. Remote stick should be connected to one 485 plug and no special initialization is necessary.

10.1 Use of Remote Stick

Plus and minus buttons have the same function as rotary Zoom knob.

Enter (✓) and escape (X) buttons have the same functions as Zoom press and Volume press.

Zoom IN/OUT:

Use buttons Minus and Plus on the Remote Stick

Select screens (APT, TP, TSK):

Use APT button and press it until you will have the indication on the top in left corner APT, TP, TSK

Select second page:

Use SUB and you will the first and second subpage of the screen

Change information at second page between info and vertical profile:

Use 1-4 button, you can also Zoom In/out with Minus / Plus

Change MC:

- Press MC
- Press Minus / Plus button
- Press X to escape

Select TP, APT:

- Press X button
- Use MINUS to go to Country, Name or Sort by distance filter
- Use Check/confirmation button to select your filter (*Example Name filter: press Check, press Plus to change the character and press confirmation, go down with Plus and select your TP, APT with Check button*)

Select in TP/APT/TSK mode

Press “check” button and windows with different functions will open, depending if you are in TP, APT or TSK mode. One of them will be yellow, which means, that this window is the current chosen one. You can move to a different window with the + or – zoom buttons. To select the chosen window simply click the “check” button again and the next window will open. Manipulation from here on is the same as everywhere else for LX remote.



10.2 Remote in second seat

Remote stick for second seat is the same as for the first seat (no different firmware as by LX 7000/7007). The unit should be connected to second seat unit to 485 bus.

11 LX Joy

11.1 General

LX Joy is an ergonomically designed, with leader covered remote stick handle for glider airplanes. It consists of 5 buttons and navigation switch on the front side, 1 button on the back side, build in electric circuit and wiring.

The internal diameter of the bore can be 19,1 mm, 20,1 mm or 24,3 mm. It is important to point out the dimension by ordering.

For more information about installation, hardware... read LX Joy manual on lxnavigation.com/manuals/

NOTE!!
 In order to LX Zeus work with LX Joy, software version on LX Zeus should be at least **3.2.2** or higher.

11.2 Button description

NORMAL MODE (LED OFF)

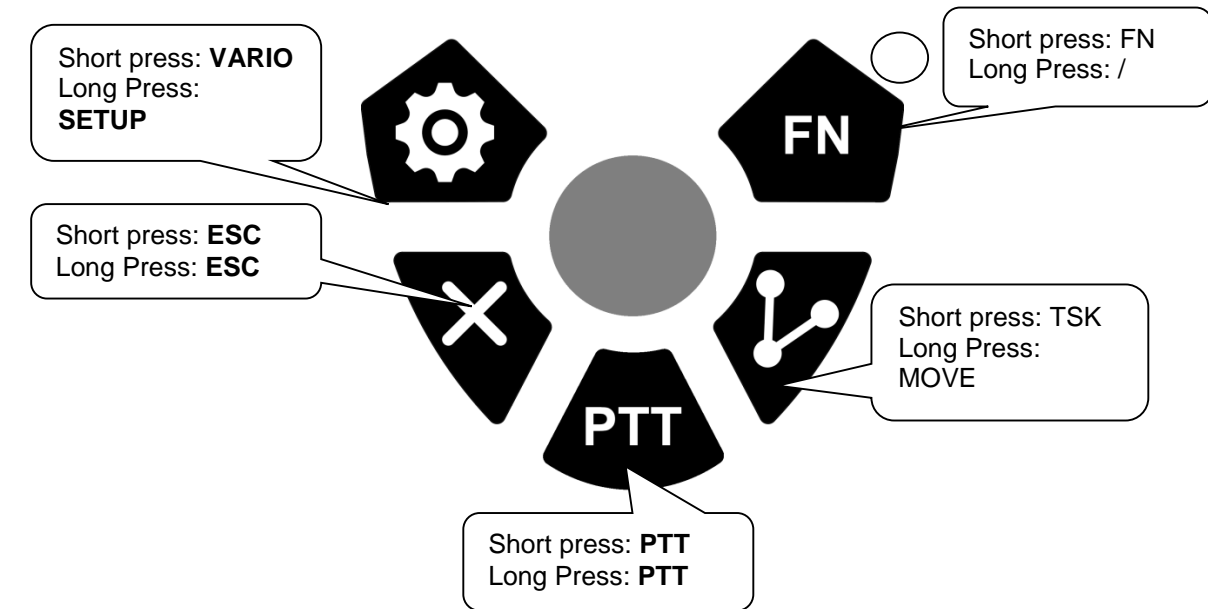

Joystick button:

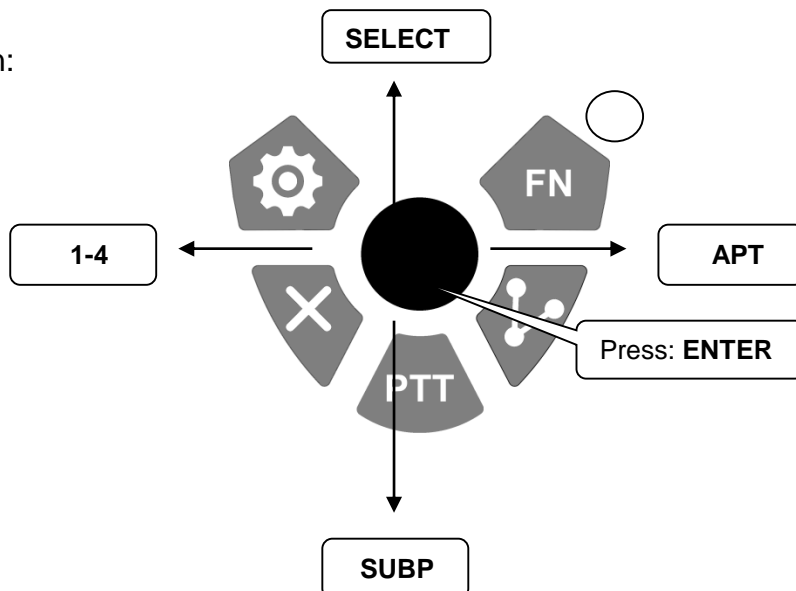

ZOOM/VOLUME MODE (LED GREEN)

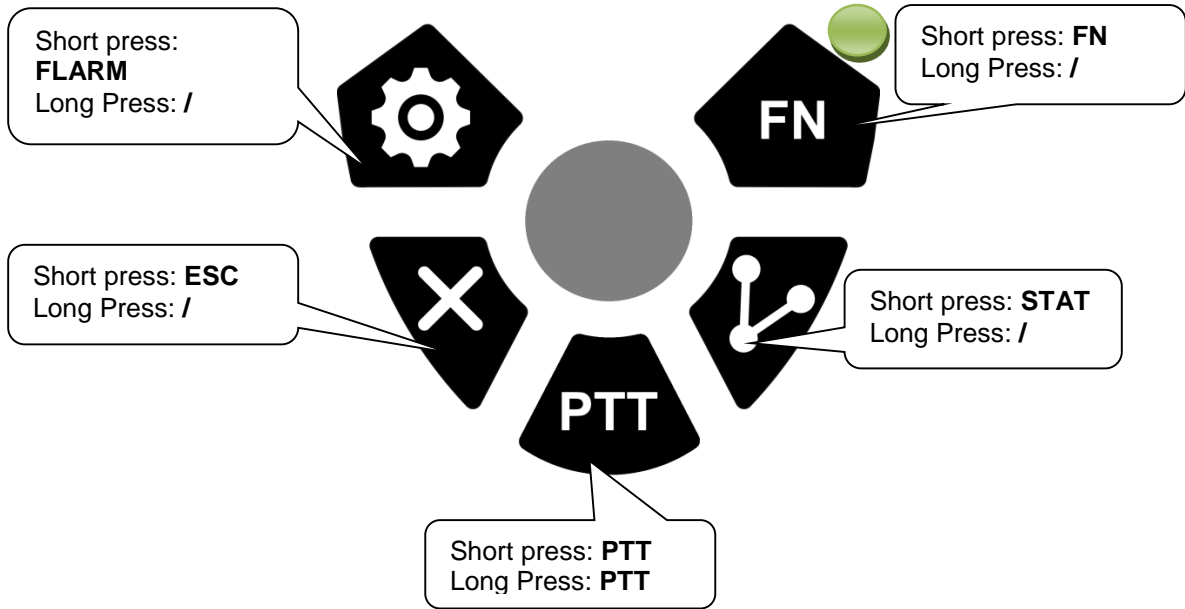

Joystick button:

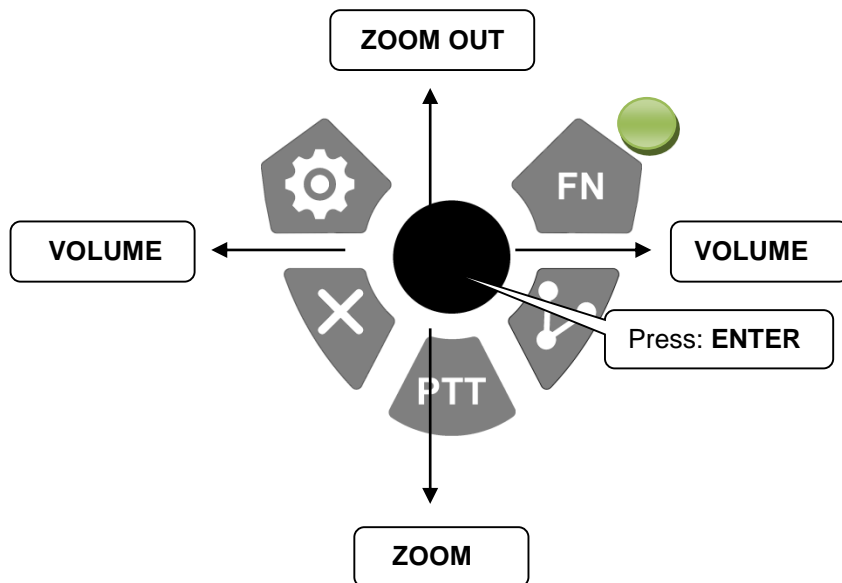

PAN MODE (LED RED)

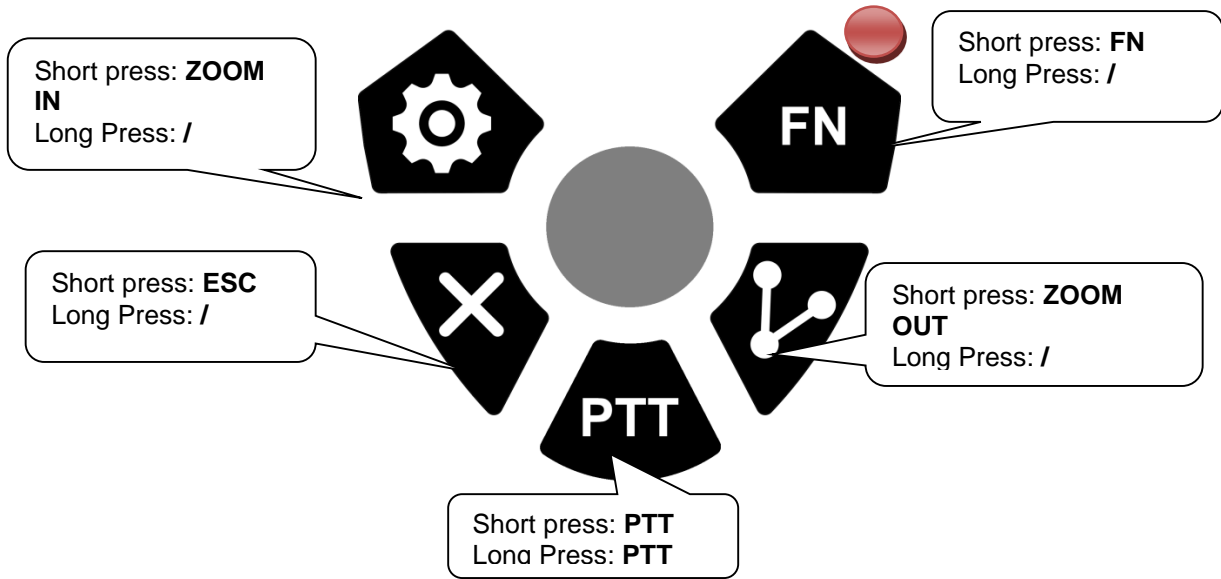

Joystick button:

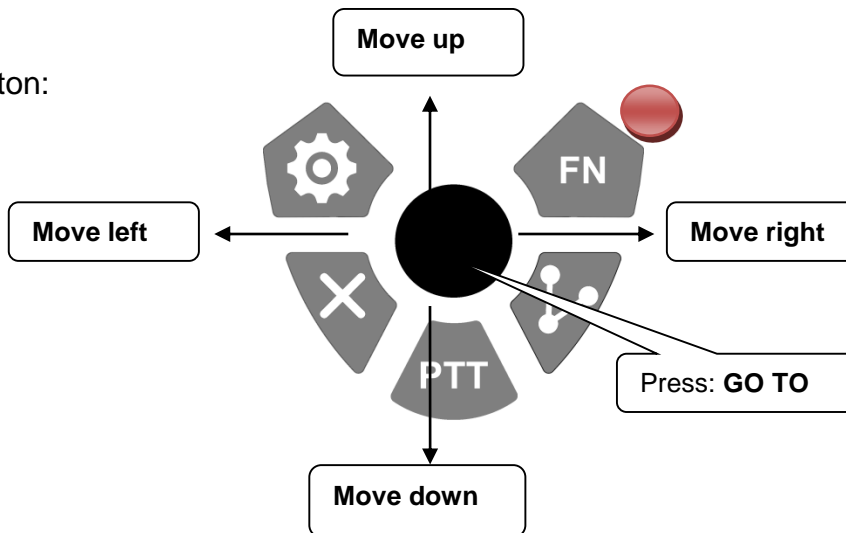

12 Second seat unit

Second seat device is connected to the master unit via **CAN bus (not important which one)**. The connection also includes power for second seat. This means that second seat unit does not need an additional power supply. An external toggle switch makes it possible to switch off the unit during single pilot operation period. Otherwise all commands are the same as by main unit. GPS inputs are inoperative, so there is no sense in connecting GPS sources to those plugs, the same is true for Flarm display plugs. All LX Zeus sizes can be also used as a repeater in case of panel space problems.

NOTE

Flarm, Colibri II, Voice module, Magnetic Compass should be connected to the first seat.

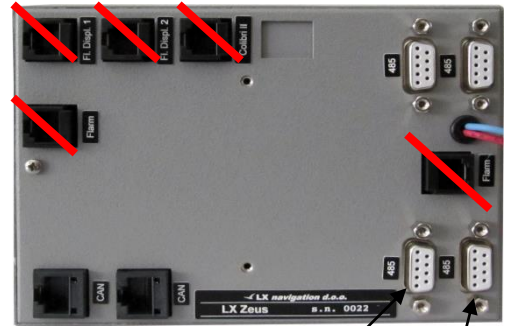

12.1 Connection of Vario and Remote

Vario indicator (not USB D unit) should be connected to 485 bus of second seat device (this is not the same as by LX 7000/7007). **The same is valid for remote.** Both vario indicators and remotes are compatible with existing units connected to LX 7000/7007. Remote doesn't require any setup.

12.1.1 Secondary Vario setup

Function of vario indicator connected to second seat unit, should be defined in Setup of second seat unit. Indicators (upper and lower indicator) on vario second seat can be adjusted from LX Zeus second seat. Automatic SC switching and external switch mode cannot be adjusted from second seat unit.

12.2 Interaction LX Zeus – LX Zeus Second seat

LX Zeus in the front seat and LX Zeus situated in second seat are two units with identical HW configuration, but the second seat unit is prepared to play slave role to some extent. The initialization for second seat should be done during production process in the factory. The units are connected via CAN marked connectors, which are to be found on the back of both units. In general the second seat unit does more or less an independent job but receives all navigation and air data from the master. All secondary interfaces such as a Remote Stick, etc, are to be connected to the second seat unit.

Following parameters are exchanged between both units:

Item	To first seat	To second seat	Automatic	Manual
Sec. pilot name	Y		Y	
Sec. pilot mass	Y		Y	
TSK /TP/APT exchange	Y	Y		Y
Team code	Y	Y		Y
Logger setting	Y		Y	

12.2.1 **TSK / TP / APT exchange**

The TSK / TP / ATP can be exchanged from first to second and vice versa. The pilot, who wants to send the task / turn point / airport, should press Zoom knob and select screen button SEND TASK / SEND TP / SEND APT. The other Zeus will receive it immediately. Zeus will send the whole task with its statistics, moved zones, limitations etc... When a task is sent from second seat to first seat the declaration is also sent to Colibri II.

12.2.2 **Downloading flights from Second seat**

Downloading flights is possible only from the First seat unit.

13 Flying with LX Zeus

It is recommended to prepare the unit for every flight before take-off to ensure a stress-free and joyful flight. This is especially important before any contest, record or badge flights.

13.1 Flight preparation on ground

It is suggested to check following:

- Data base status
- Prepare task (use new or edit options, or select imported task)

13.1.1 Before take off

- Switch the unit ON at least **3 minutes** before take-off (this will ensure sufficient GPS reception and will create a base line of the baro trace)
- Select correct **pilot** (many settings belongs to pilot)
- Check task if it is correct after using of **Task edit**
- The task actual during take-off will be **declared** in Colibri II and Flarm
- Switch on **second seat** unit in case of double seated glider

13.1.1.1 Setting of the take-off elevation

LX Zeus requires **take off elevation** input at initial Setup. The elevation of the last landing place is offered. If this doesn't match the elevation of actual take off place an adaptation is necessary. User can also set QNH, select pilot (profile settings), polar (if 18m glider then probably 2 polars inside) and set ballast.

On second seat unit is possible to select only a flying pilot, other data has to be selected at the first (main) seat unit

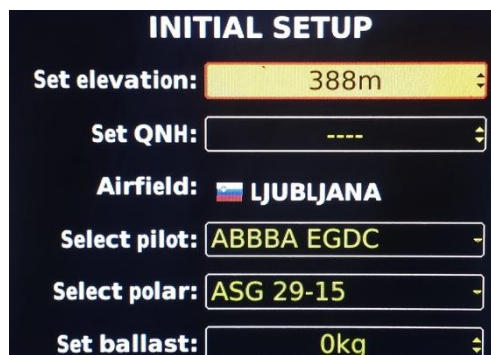

13.1.1.2 QNH setting

The pilot should input actual QNH value of the airport where he will take off. This action should be carried out on ground, after take off the menu will not open any more. After input of QNH on ground the pilot will be able to adjust altitude reading during flight, if QNH will change (select vario, flarm button and go to QNH box and edit the value).

Note!

QNH setting doesn't replace **setting of elevation** during booting, this should be carried out every time otherwise the unit will not switch to navigation mode. QNH setting isn't obligatory and may be neglected.

13.1.1.4 Task declaration process

The task declaration process is fully automatic and doesn't need any pilot interaction. **Actual task and pilot data** will be written into both flight recorders immediately after selection. The declaration data will not change during flight, even if task data will change due to select or edit process (IGC rule). The action is accompanied by a message on the display.

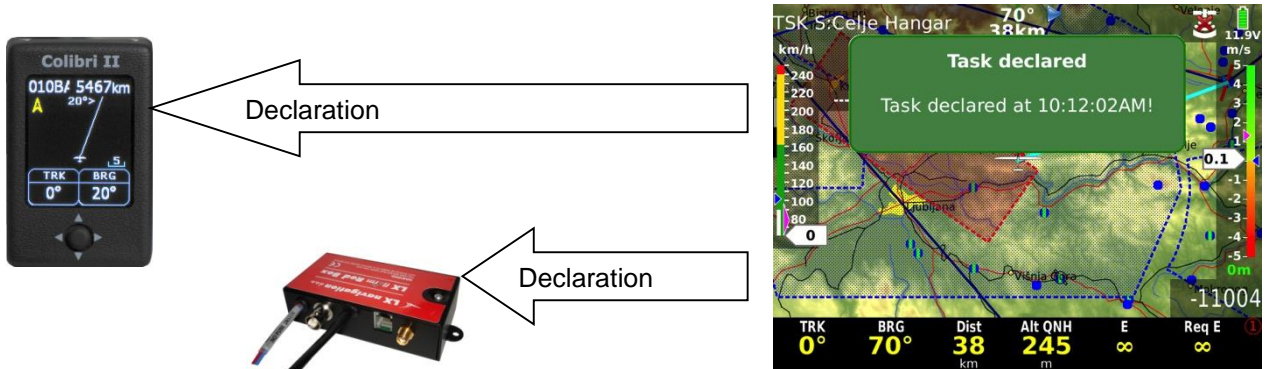

13.2 During flight

The Zeus HW and SW concept is so far optimized that the pilot doesn't spend too much time to operate the unit during flight. It is important to point out that there are many short cuts, which enable direct and fast access to most important functions. The pilot isn't obliged to terminate edit process until end due to Auto close feature, which closes the process after some seconds of no active commands. A very **significant indication that shows** that the unit has changed to flying mode is Log Book replacement with statistics page after pressing on **STAT** button.



13.2.1 Set MacCready, Ballast, Bugs and QNH

After short press on VARIO button a new window will appear – MacCready. The menu will give options, to adjust MacCready, Ballast, Bugs and QNH. Setting MacCready, Ballast and Bugs will have affect on the glider polar: MC speed, sink speed, cruise speed and also the efficiency will change.

Bugs setting will decrease the efficiency, which will affect the final glide calculation.

Example:

- efficiency is 30
- bugs setting is 10%

$$\begin{aligned} \text{Equation: } F_{\text{bugs}} &= f \times (1 - \text{bugs [fraction]}) \\ &= 30 \times (1 - 0.10) = \\ &= 30 \times 0.9 = 27 \end{aligned}$$

QNH setting:

The pilot should input actual QNH value of the airport where he will take off. This action should be carried out on ground, after take off the menu will not open any more. After input of QNH on ground the pilot will be able to adjust altitude reading during flight, if QNH will change.

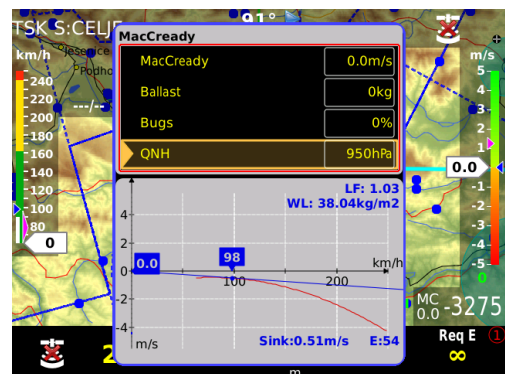

Note!
QNH setting doesn't replace **setting of elevation** during booting; this should be carried out every time otherwise the unit will not switch to navigation mode. QNH setting isn't obligatory and may be neglected.

13.2.2 Statistics

The statistics page will open after press on STAT button.

Statistics page offers following statistics data:

- **Thermal analysis (1 and 2)**
- **OLC**; calculation of OLC points
- **Baro**; shows baro trace from take off until present position
- **Task**; presents task statistics data divided by legs
- **Route**; shows Task and distance flown

Note!

When the task has not been started yet, the statistics data is limited to take-off and flight duration.

The statistics page colour structure can be adapted under pilot personal requirements, after using of; **Setup/User Interface/Statistics colours**

Note!

If task consists of more than three legs, use **zoom** to select legs of interest.

End Flight function will close the flight, so don't use it during flight. After execution the flight will end and the flight recorder (Colibri II) will be forced to close the flight.

13.2.2.1 Thermal Analysis

There are two pages of thermals statistics, which are selectable by pressing the VARIO/FLARM push button:

- **Thermals 1**
- **Thermals 2**

Thermals 2

The page shows all thermals of the flight, as a reference the actual MC setting is shown. The value corresponds to thermal vario of individual climb. This means from entering and leaving the thermal. The thermal is shown if you gain at least 100 m of altitude. The thermal is shown if you gain at least 100 m of altitude. The dotted red line through the columns shows the MC setting. This assists you in determining a good MC setting.

Thermals 1

Every column means a thermal. The column is sliced into various colours and widths. The colours are blue, yellow and red. These colours depend on the current MacCready setting. If the thermal strength is below MC setting, then the column is blue, if it is above then the colour is red. The yellow colour is around MC setting (plus / minus 20% of MC).

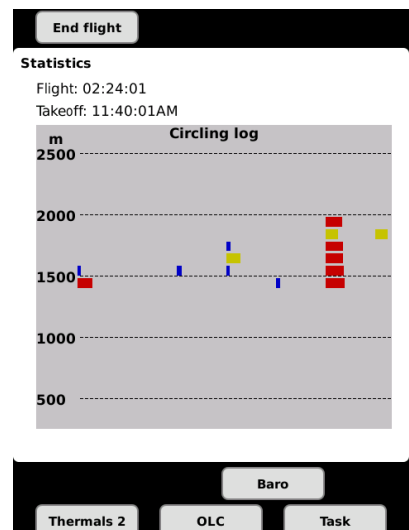
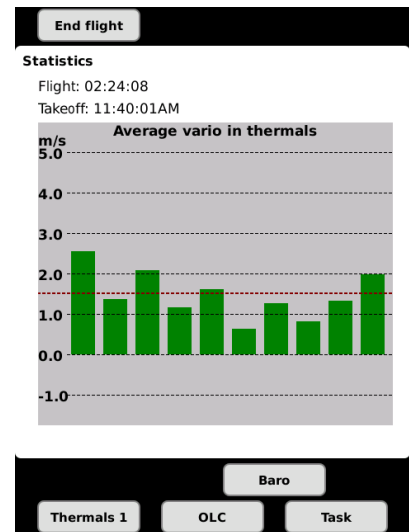
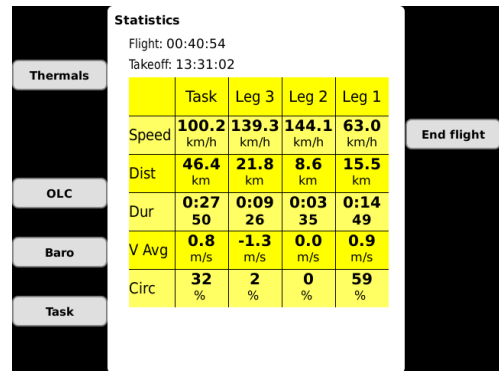
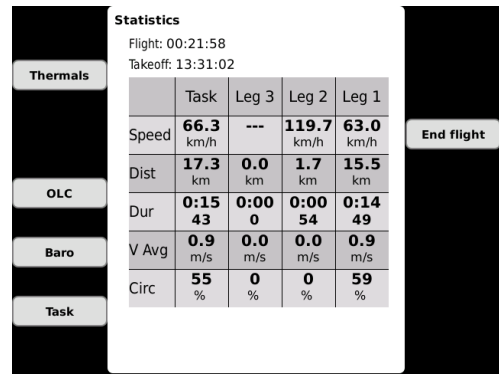

13.2.2.2 OLC Calculation

OLC calculation is calculation of OLC points according to OLC rules. Current rules can be read on <http://www.onlinecontest.org/olc-2.0/gliding/cms.html?url=rules>.

In general the scoring software selects a departure point within the powerless part of the flight and fixes up to 5 way points (turn points) and a finish point in such a way that the following two conditions are fulfilled:

- The raw point score (1 point per km) from the departure point via all waypoints to the finish point is a maximum.
- The departure altitude is not more than 1000 m higher than the finish altitude.

To stimulate „area“ flying, a so-called FAI bonus is granted. For this purpose, the scoring program checks whether FAI triangles can be fitted into the flight route and, if so, determines the largest such triangle for calculating the FAI bonus.

There are three NAV BOXes showing how many OLC km were made (so far). One is OLC and means the kilometres made to current point in flight. The other one is OLC HOME and means how many kilometres will be made if the take-off point is reached. The third NAV BOX is OLC speed, which indicates your speed over the whole OLC distance flown.

13.2.2.3 Baro trace graph

A baro trace from take off until actual position will open after press on button next to **Baro**. Customisation of colours is possible at **SETUP/USER INTERFACE/STATISTICS COLORS**.

13.2.2.4 Task Statistics

The page will open after press on the button that you will find close to Task window. The statistics data is shown for the whole flown task and also for individual legs.

- **Speed:** average speed
- **Dist:** distance flown
- **Dur:** duration
- **V Avg:** vario average (based on leg resp. on task)
- **Circ:** percentage of time spent in circling

Note!

Use Zoom to scroll through the legs, as the display is capable to show only 4 legs. An infinite number of legs can be shown.

Statistics can be seen also at the first subpage in TSK mode.

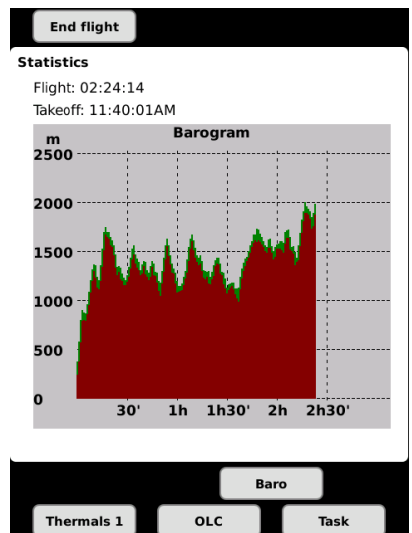
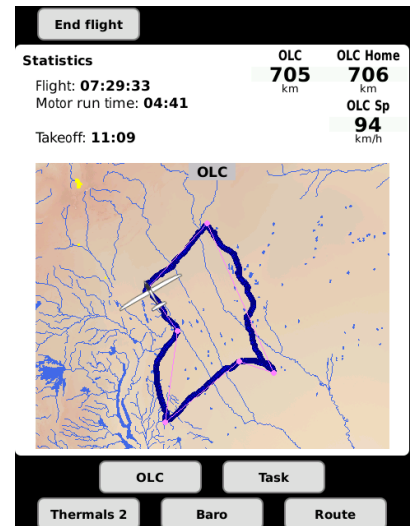
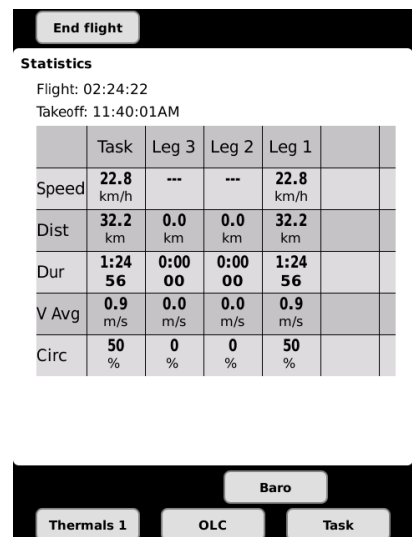
End flight

Statistics
 Flight: 02:24:22
 Takeoff: 11:40:01AM

	Task	Leg 3	Leg 2	Leg 1	
Speed	22.8 km/h	---	---	22.8 km/h	
Dist	32.2 km	0.0 km	0.0 km	32.2 km	
Dur	1:24 56	0:00 00	0:00 00	1:24 56	
V Avg	0.9 m/s	0.0 m/s	0.0 m/s	0.9 m/s	
Circ	50 %	0 %	0 %	50 %	

Thermals 1 **Baro** **Task**

13.2.2.5 Route

Route option is a feature showing the path already flown and current task, so detours made can be seen.

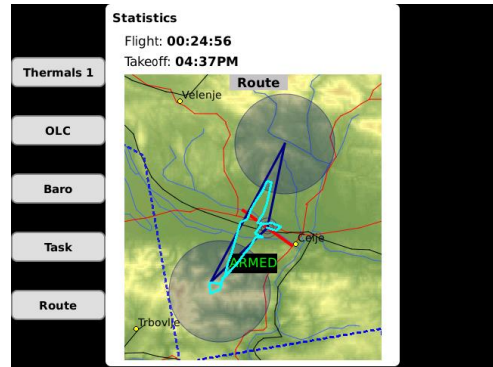

13.2.3 Special functions

13.2.3.1 Event function

This function is active only if Colibri II is a part of the system. A long press on **EVENT** button will send a command to Colibri II flight recorder to activate so called event function. This is in fact recording in shorter intervals as default for a limited time (default: event fix interval: 1s; event repetitions: 20). The conditions are to be set in **Setup/Logger** of Zeus. The action is accompanied with a clear message.



13.2.3.2 Marker setting

If the pilot wants to mark a position of interest, for example a suitable outlanding place, thermal hot spot...), this can easily be done by activating of **Marker function**. The process is very fast and doesn't intensively occupy the pilot.

To mark a position pilot should do as follows:

- Select screen **TP**, press **Zoom**
- Select screen button **Add marker**.

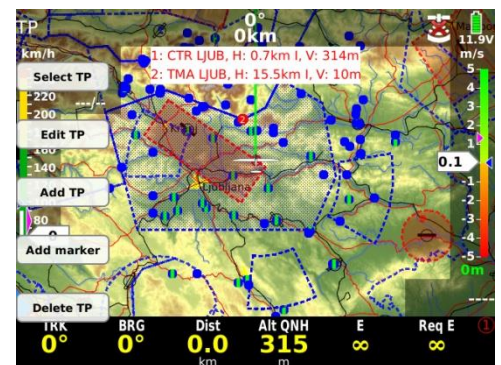

The marker is visualized as a yellow triangle positioned on the graphic page. Only one marker can be active at the same time. To set a new one simple repeat the procedure.

The marker will be stored as user turn point designated as **#MARKER**. If the edit function is used **#MARKER** can be converted into normal TP. **#MARKER** can also be deleted after using the **Delete TP** command. In case of navigation data necessity towards **#MARKER** point, simply select **#MARKER** after using of the Select TP command.



NOTE:
Marker function is possible only on TP screen

13.2.3.3 Pan mode

It enables you to move on the map using volume and zoom rotary switches. Pan mode is available in all three modes TP/APT/TSK.

To activate the mode, press button SELECT and choose screen button pan mode. Now you can move to the desired location on the map and if you use GO TO command a new virtual TP will be set in TP mode, and navigation to TP is active.

To move more efficiently use zoom in or zoom out. Tail (already flown track) and farm objects are visible on map in pan mode.

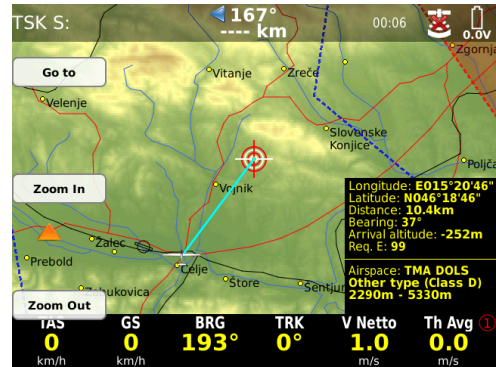

13.2.4 Task Start

Task start is a quite complex procedure, especially with a high density of gliders where many of them intend to start at nearly the same time. As the pilot intends to perform task start in an instance, a very simple operation should be carried out:

Press on TSK button and confirm ARM option

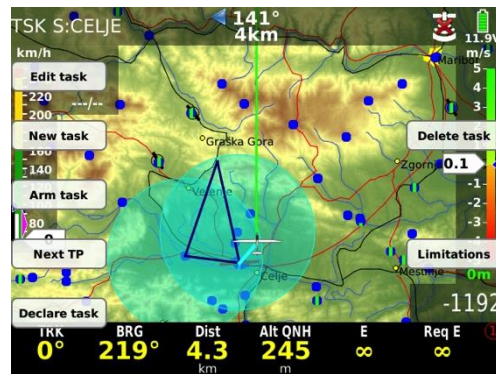

A very significant message **ARMED** will appear on the display. Armed word will remain on line until **first line crossing**. After crossing line, the task will start automatically without any further pilot interaction. Task start is accompanied with a very significant message:

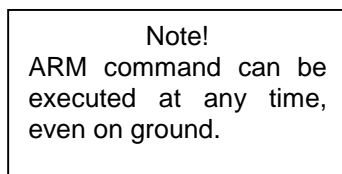

If you then cross the start line multiple times, the time of the last valid start will be used for statistic calculation. Every next start is also visualised by a green message TASK STARTED..

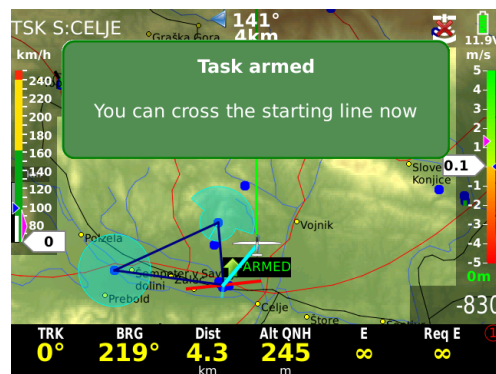

Disarm function will disable Arm command.

NOTE:

In case that the pilot forgot to ARM start and has crossed the line, execution of **NEXT TP function** will solve the problem. Navigation to first turn point will be offered and the statistic page will become available. It will take the last start line crossing time for a valid start. This also ensures correct statistics data.

13.2.4.1 Start Conditions / Limitations

Some competition rules prescribe some limits (restrictions), which should be respected before start and also at line crossing. After short press on TSK/MOVE a screen button Limitations will appear. Press SUBP to enter limitation option. Limitations are divided to:

- Gate time
- Before start
- Start conditions

Gate time means the time when the start line will be opened. Calculated time will be time set in Zeus (UTC or UTC offset time). Zeus time is default set to the UTC time. Time can be changed in SETUP/LOCALE/UTC offset.

Below start altitude and time can be set. The glider should be below selected altitude the time you set.

Start conditions can be limited to start altitude and ground speed.

Limitation indicator will appear on the screen (only at TSK screen).

Stop, because the start limit GS speed is too fast.
B =before start, S = start conditions

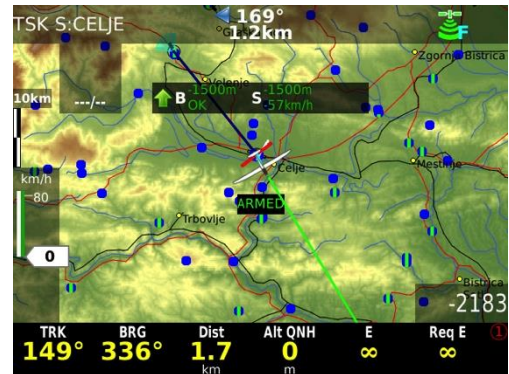
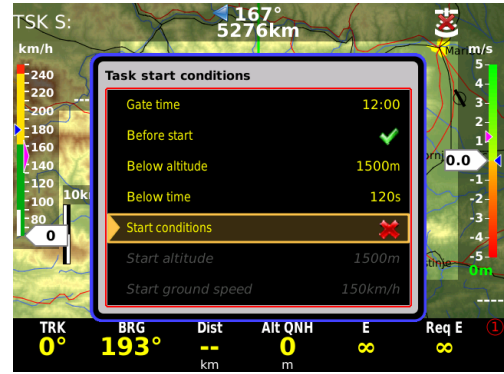

13.2.4.2 Task Restart

After a bad start and intention to perform a new start, the pilot is able to execute the so called **Restart** function. After a press on TSK/MOVE button you will find screen button **RESTART**. After pressing restart, the task will be reset (doesn't matter on which leg) and a new start can be performed. Also the task statistics will be reset.

Note!

After RESTART, the unit will change immediately into **ARM** status, which means ready for next start.



13.2.4.3 Restart Leg

Restart leg is possible during active leg. After press on TSK/MOVE button you will find screen button RESTART LEG.

13.2.5 Task Finish

Task finish will be detected after the glider will pass the finish line. The situation will be accompanied with a very clear message and also with Task speed.

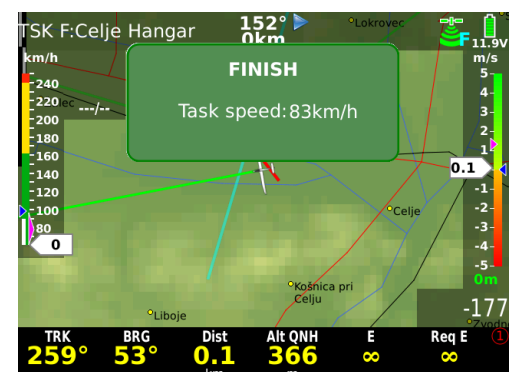

13.2.6 Flying AAT (Assigned Area Task)

AAT (Assigned Area Task) is a modern manner of task flying on competitions. The basic idea is to set relative big sectors around turn points and this makes it possible that the pilot decides how deep into the sector he will fly. The main objective is to gain a highest possible average speed, while choosing your own route of flight, limited in the given AAT sectors.

Create an AAT:

- TSK/MOVE; New task or Edit task
- **Task time – MUST BE SET!**
- Set sector geometry – go to TP, select Zone, edit R1(10 km and more) and A1 (180)
- Move function: makes possible to adapt AAT distance and also get informed about important task parameters as for instance: remaining distance, required speed....

Move function is also available after long press on TSK/MOVE push button. Use Zoom and Volume rotary switches.

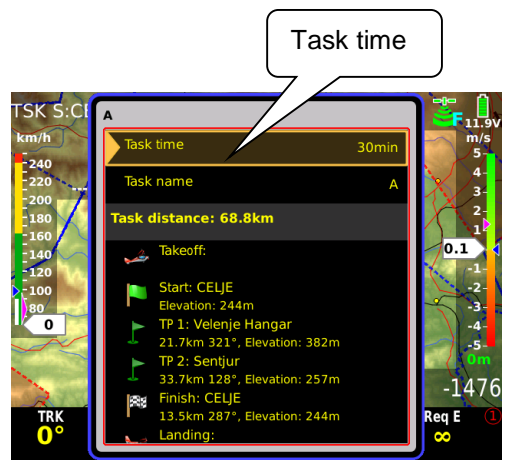
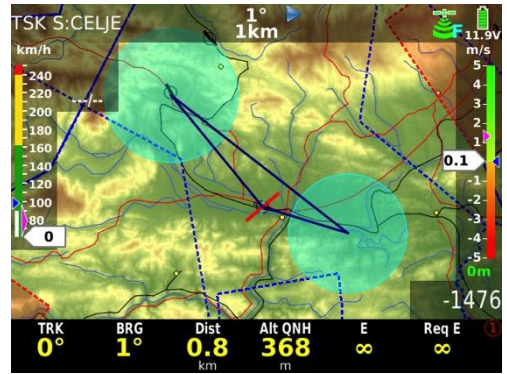

Note!

If task time will not be set, there will be a lack of many statistics data, for instance: task delta time, task remaining time....

Note!

If sector radius is bigger than **10km**, the unit will recognize this as an AAT and will set manual change over to next turn point. Using smaller sectors by AAT requests manual setting of **No** Auto next.

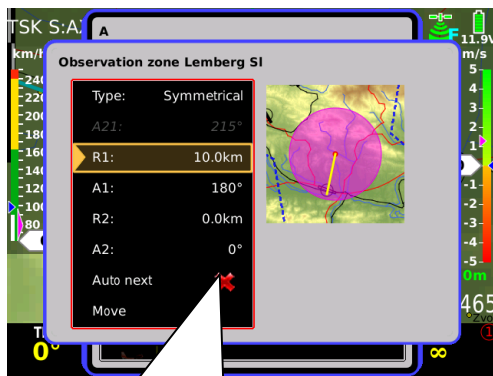

Auto next X because R1 is more than 9.5 km

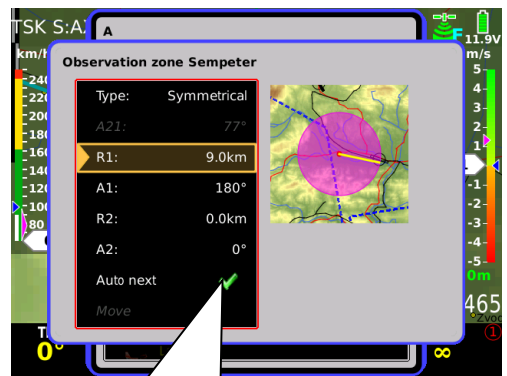

Auto next because R1 is less than 9.5 km

13.2.7 Final glide calculation

The final glide calculation is based on the following inputs:

- Actual MC setting
- Wind
- Polar
- Bugs
- Ballast
- Safety altitude (reserve)

Note!
Final glide may be also visualized as NAV BOX.

The final glide is indicated in the graphics page. As the final glide box has the nature of a display indicator it can be moved over the display and also custom colours can be assigned. (-) figures mean below and (+) above final glide, both in meters resp. in ft. The final glide situation is also present in the first navigation Subpage of all three navigation modes. In case of flying a task, final glide profile will be displayed until finish through all TPs.

It is also possible to select final glide with the current MC setting. This can also be shown as a display indicator or as NAV BOX.

Note!
In Task mode the final glide is calculated from actual position until finish (overall not over flown turn points).

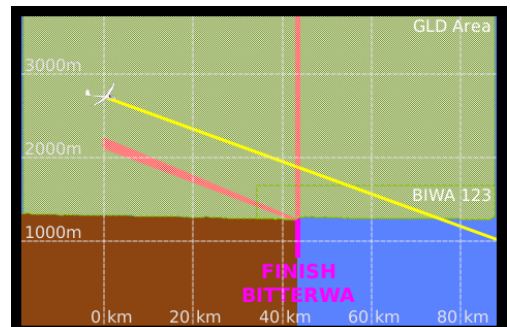
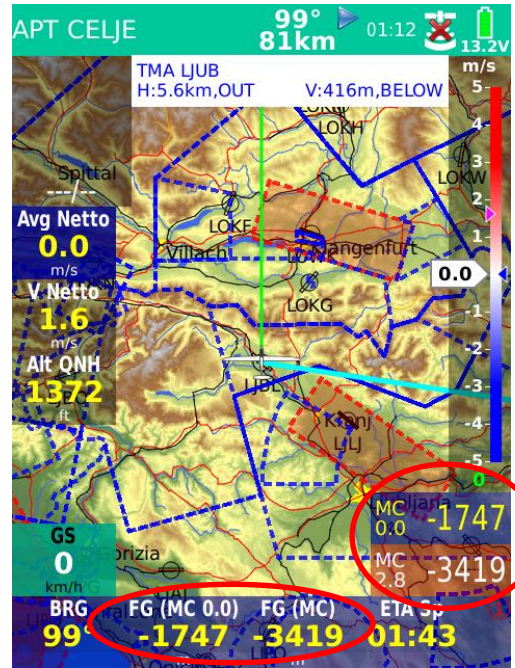

Task	Leg 4	Leg 3	Leg 2
Speed	85.1 km/h	84.3 km/h	94.2 km/h
Dist	670.3 km	177.0 km	151.6 km
Dur	7:52:54	2:06:06	1:36:38
V Avg	1.7 m/s	2.1 m/s	2.0 m/s
Circ	33 %	26 %	28 %

13.2.8 Finish line crossing

Modern competition rules use longer finish lines and also finish cylinders. Zeus is always calculating **the shortest way** to reach the finish and therefore offers the shortest distance to reach the finish. In the final glide calculation the shortest distance is also taken in account.

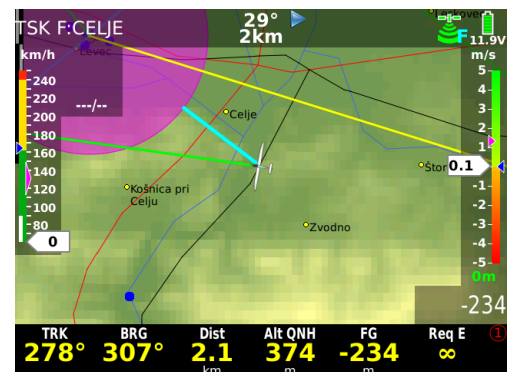

13.2.9 Thermal assistant

The thermal assistant analyses the thermal while circling. The size of the dot indicates the strength of the thermal – bigger dot means stronger lift.

Dots are different colours and depend from MC set.

DOT color:

- Red colour means values above MC,
- blue values below MC,
- yellow dots show lifts plus/minus 20% of MC setting.
- White dot shows the maximum of the thermal

NOTE:

If the indicator shows mostly red colours, then we should increase MC, if colours are blue, then the MC should be decreased..

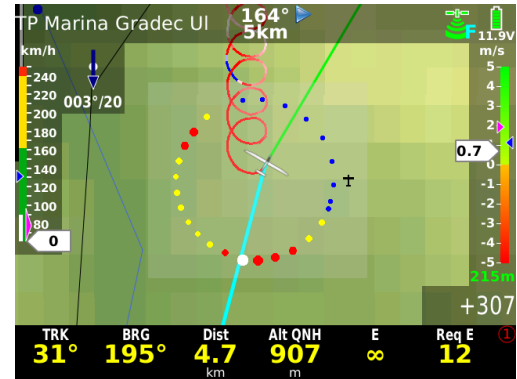
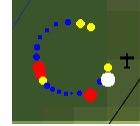
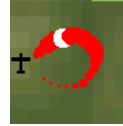

A symbol of a glider will appear on the right or left side of the circle. The glider on the right side means, that you are circling left and the thermal is on your left side.

In Setup/Layout the size and position of a thermal assistant can be customized (see picture beside). Default position is left corner bellow IAS.

13.2.10 Flarm management

Unit will show Flarm objects if a Flarm is connected. There are two screens that are able to display Flarm objects. Objects will be seen on MAP as a glider icons and at Flarm radar, which can be opened after long press on VARIO/FLARM push button. Number of shown objects is infinite.

Objects on the map will appear automatically with data about object's current vario and altitude difference.

At the Flarm radar page, objects can be customized (Call signs and colour). Three objects can be selected at once, but there will be infinite objects on the radar. Zoom can be also adjusted at radar.

Procedure:

- Long press on VARIO/FLARM will open a Flarm radar.
- Rotate Volume to adjust Zoom on Flarm Radar
- Rotating Zoom knob will move an orange frame to select/store 3 objects on the bottom in a box
- Press Zoom to select the object in a range
- Long press on Zoom will open a dialogue with more details about selected object. Rotate zoom to select the details you want to see or modify
- Press Volume to Escape from dialogues

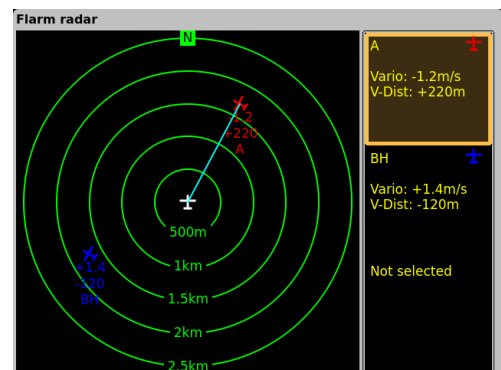
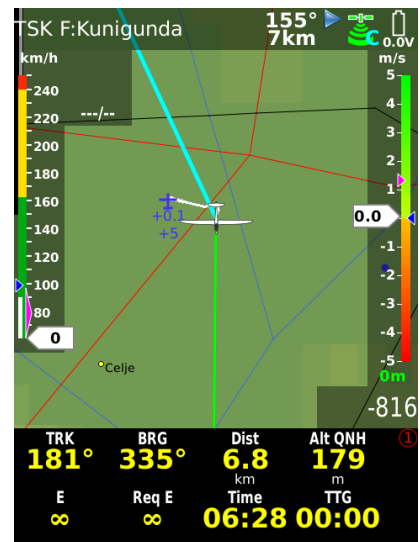

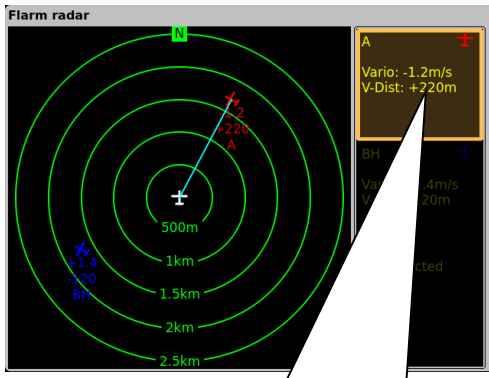

Red glider is selected, zoom can be adjusted

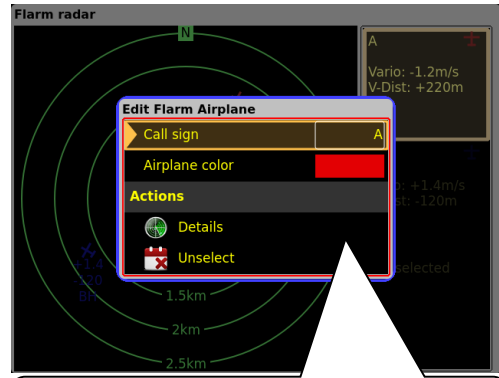

Edit dialogue will open after a long press on the selected flarm object.

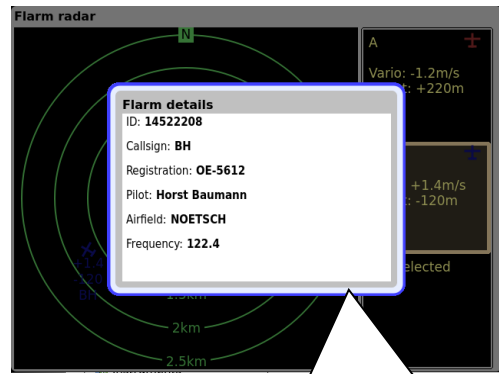
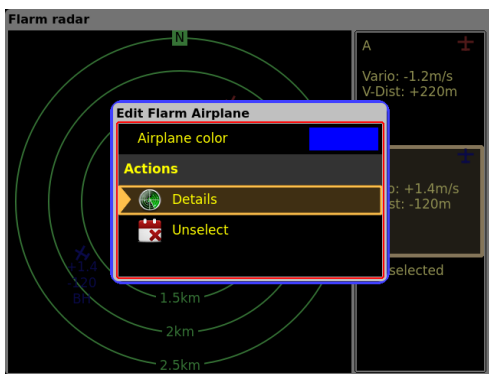

Flarm details can be seen if a FlarmNet file is installed in Zeus

13.2.11 Artificial horizon – AHRS

Artificial horizon (AHRS) is offered as an integral part of the system, no external boxes necessary. AHRS is not possible for Zeus 4.3.

You can view AHRS by pressing subpage or you can put AHRS as an indicator on the main TP/APT/TSK page.

Artificial horizon as a box is also possible. Simply connect it with CAN cable to first seat unit (Plug and Play).

Important!

Orientation of AHRS box is very important. It has to be installed as it is shown on the label of box unit (little black glider icon)

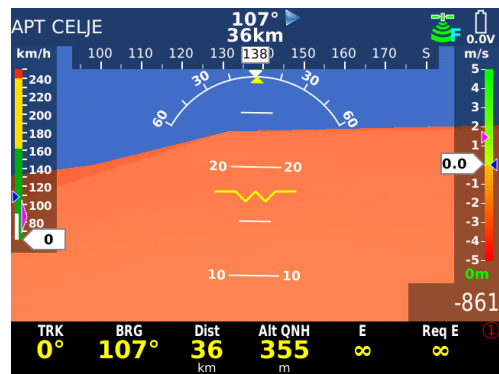

Pressure connection:

- Pst – connect static pressure
- Ptot – connect dynamic pressure



13.3 After landing

It is recommended to keep the instrument ON for a few minutes after landing; this will ensure base line of baro trace.

There will be a small window, which will show: **Flight will end in** __ time left till logger will stop recording). After the flight will end simply wait until a very significant message on the display will appear (calculating security). It shows that flight recorder is terminating the flight and data security operation of flight recorder is in progress. After calculation of security, statistics page will be replaced with **Log book** and the unit is now ready to be switched OFF, or flight download process can start.



13.3.1 Downloading of flights

LX Zeus can fully interact with Colibri II in case that Colibri is used as a flight recorder. This means that downloading Colibri II flights is possible directly from LX Zeus. The stored flights can be transferred to a USB stick.

If there is no connection between Zeus and Colibri II, the unit (Zeus) will offer its own “flights”, which are not IGC approved.

The flight file structure meets IGC standard and therefore such flights can be evaluated by any program that accepts .IGC data format.

In case of Flarm (RB IGC version) connected to LX Zeus, its flights will be stored to Flarm SD card, without any Zeus interaction. The procedure is automatic, and the new flight will be stored after next power on.

NOTE:
In case of Red box flarm, it is possible to download flights only if there is 1 SD card inserted, either directly into RB or into the SD card slot in the front panel of Zeus.

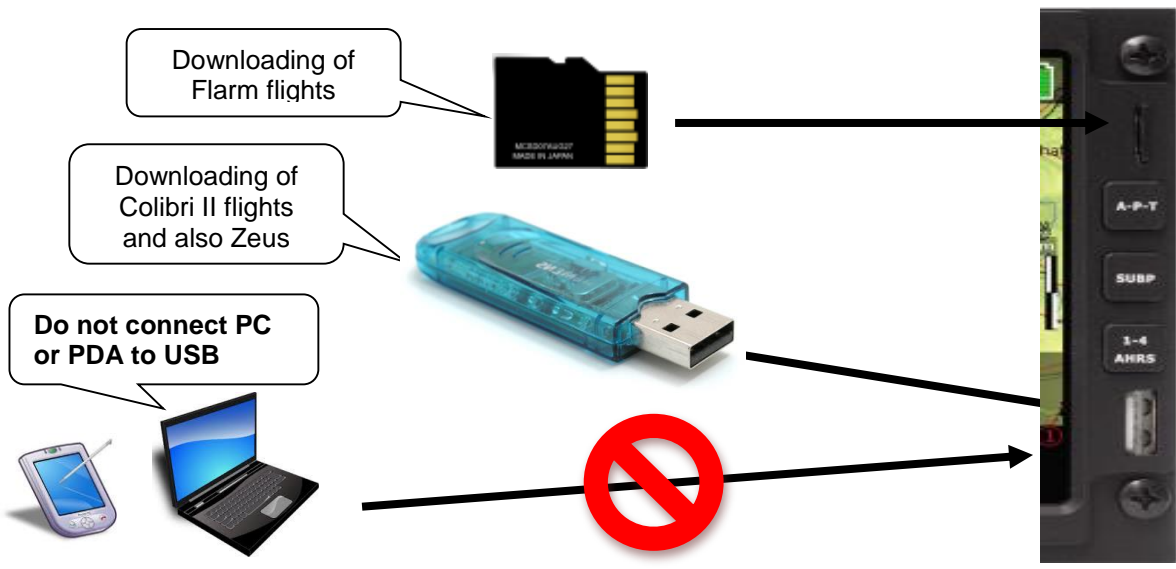

Note!
Downloading flights from second seat is not possible – only from 1st seat.

13.3.1.1 Downloading Colibri II flights

After finishing of the security calculation process, downloading of flights can begin. Downloading of flights stored in Colibri II is possible exclusively by using of a USB stick.

The procedure:

- **Insert USB** stick
- Press **STAT** button (log book will open)
- **Select** flight of interest
- Execute **Save to USB** command

The process will take a couple of seconds or minutes a significant message will show termination.



Note!
In case of troubles (error messages USB not detected.....), switch Zeus OFF, remove USB stick, switch Zeus new ON and try again

Password 46486!
This password will delete all flights stored in Colibri II and also all pilot history in ZEUS!

The flight is now available on USB stick in LX folder **Flights**. Flight data is stored in .IGC format and therefore immediately ready for evaluation. The data security level meets the **IGC high level** approval standard.

13.3.1.2 Downloading of flights recorded by Zeus

LX Zeus is also storing flights in its internal flight recorder memory. The flights become available and also downloading will be possible if Colibri II **is not connected** to the system. In that case the flights in the logbook will be designated with a ✗. The procedure is the same as described in 10.3.1.1, the only difference is, that such flights don't have valid digital signature (not valid as IGC flights, but can still be used for OLC scoring).

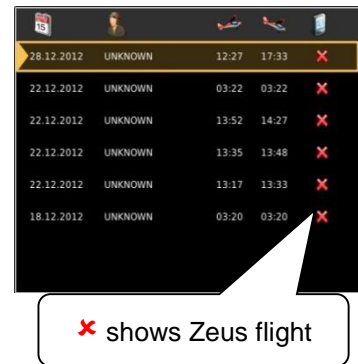

13.3.1.3 Downloading flights stored in Flarm

If an IGC approved Flarm Red Box unit is connected to LX Zeus, it's possible to directly download a flight via the SD card slot, which is positioned on the front panel of LX Zeus. The SD card slot is wired directly to Flarm Red Box SD card reader without any Zeus interaction. General rule by Flarm is, that flight will be stored to SD card after next power on. So, power LX Zeus off and on to download the latest flight. It is suggested to keep an SD card all the time in Zeus SD slot, to avoid long waiting times by downloading of many flights that are not on the SD card yet.

If the card is empty, than the first power ON will download ALL FLIGHTS stored in the Flarm and this will take a long time. It will download the last 20 flights stored in Flarm. Flarm will always store maximum 20 flights, so, if you will make 21st flight, than the oldest flight will be removed automatically.

13.3.1.4 Colibri II – Zeus interaction after landing

After landing is detected, Zeus will wait for **2 minutes** and if during this period no movement will be detected the procedure to close the flight will start. After the time out (2 minutes) the unit is ready for the download of flights stored in Colibri II.

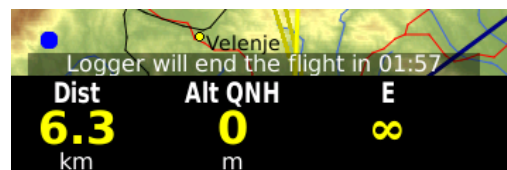

Recommended!
Keep Zeus on until above-mentioned process is finished.

Note!
Separate switching off of Colibri II isn't necessary.

After Zeus will be powered **OFF**, Colibri II will **remain ON** for a limited time (approximately 5 minutes) and will then switch off automatically. This will not happen if Colibri is in flight mode while running on the internal battery.

NOTE:
Zeus **losing power in flight** will not result in Colibri switching off

13.3.2 Recommendations for safe operation

- Connect Colibri II to Zeus before Zeus is powered on
- Never switch Colibri II OFF by hand if connected to Zeus*
- Leave Zeus ON until flight in Colibri II will finish (2 minutes after landing)
- Keep Flarm SD card inserted, so that only the last flight should be copied

*In case you have switched **Colibri II off** by hand, turning ON by pressing of Colibri II push button will not work. You should power OFF and ON ZEUS. Colibri will switch on automatically as the power from Zeus will be applied.

13.4 ICAO charts

LX Zeus offers use of ICAO charts from Rogersdata and Deutsche Flugsicherung. Charts can be ordered via update-service@lxnavigation.si. Please read **Data transfer** (section 2.2.4) for installation process. The charts will be shown by rotating Zoom knob to the left. There are 3 zoom steps available for ICAO charts.

Zoom steps from left to right:

- Task zoom (vector maps)
- Icao zoom 1
- Icao zoom 2
- Icao zoom 3
- Map zoom 1:2500000
- Map zoom 1:2000000
- Map zoom 1:1000000
- Map zoom 1:500000
- Map zoom 1:250000
- Map zoom 1:125000
- Map zoom 1:62500
- Map zoom 1:30000
- Map zoom 1:15000



Deutsche Flugsicherung

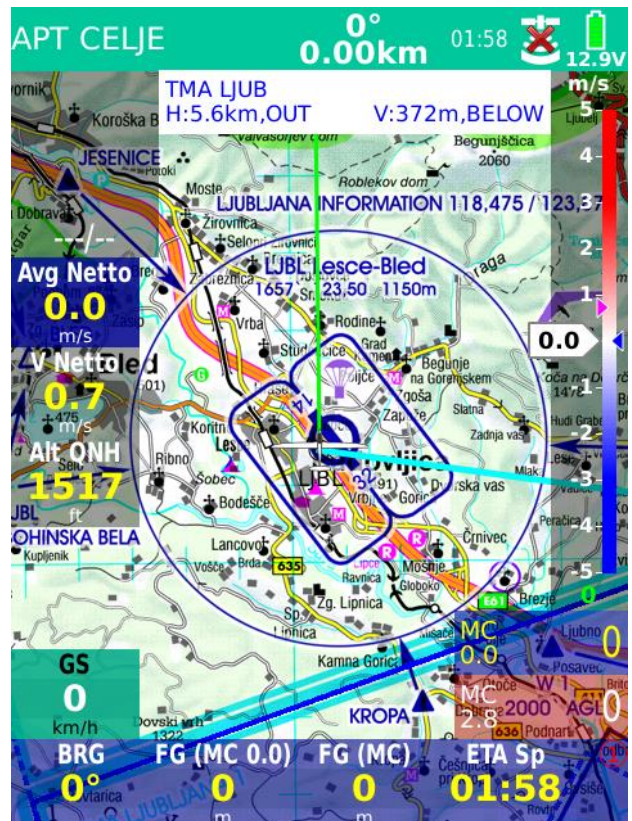

Rogers data

Note!
End of the chart will be shown as white background on the screen.
If the glider will be located out of the chart, than the ICAO chart won't appear – vector maps will replace it.

14 Installation

14.1 Mechanical installation

As the larger unit dimensions does not match air norm standard, a new cut out in the panel should be made. There are two ways how to prepare the panel.

The first option is to buy a new panel from the manufacturer, and the second solution is to upgrade your existing panel. A panel upgrade can also be done by user; in that case some experience in fiber glass technology will help. Instructions how to rebuild the panel can be obtained from LX Navigation.

Every unit comes with an iron template which makes it possible to manufacture LX Zeus cut out by hand. In case of a CNC solution, please ask for .dwg file.



Reinstallation after panel upgrade

14.1.1 Installation of Vario unit

The unit occupies one 57 mm standard cut out. The maximal dimensions of the unit are 60x60 mm and don't exceed dimensions of classic pneumatic instruments. In case of space problems, the unit can be separated into two parts, which are connected via a cable.

Note!
Respect labels near pneumatic connectors, during pneumatic tube connection process.

14.2 Screen rotation

Software rotation can be easily done in SETUP / SERVICE menu, when a password 9109 is entered. Buttons must be rotated by hand. Follow procedure below:

1. Open the unit (remove all screws and a cover)
2. Move rounded rubber to the middle
3. Take out the button and rotate it to the proper position
4. Put button back on blue button (be careful that blue button is inside of the black hose)
5. Put rounded rubber back to the first position (be careful on side with Rotary knobs rubber must not be fully pushed to the end)

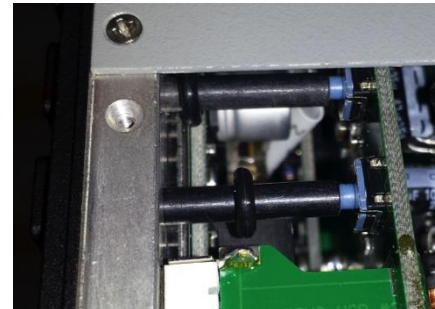
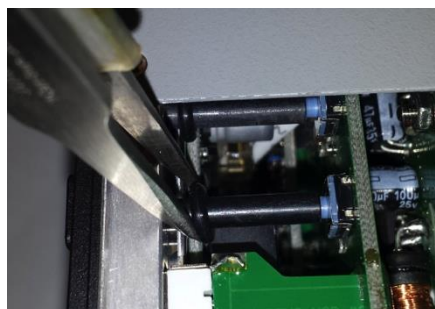
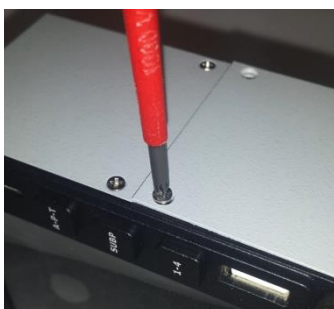

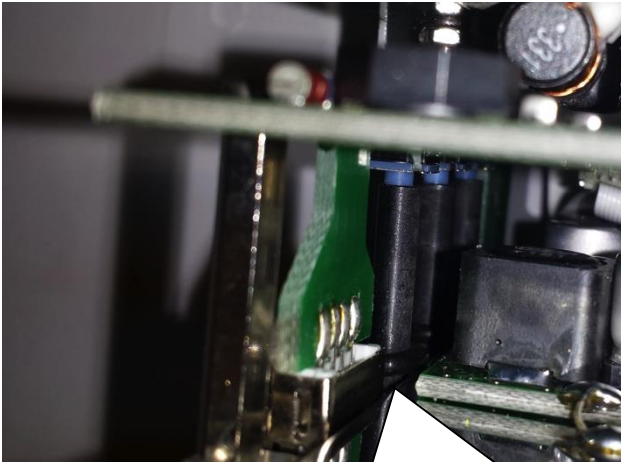

At this side the rounded rubber is touching the back plate of display, do not push it too tight

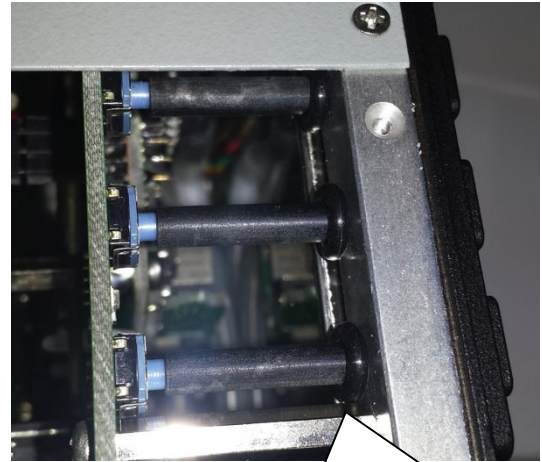

At this side the rounded rubber is pressed fully to the plate.

14.3 Electrical installation

This part of installation is easy and doesn't need any specialists. The system receives its power via two power lines, which should be connected to 12V glider power source and ground. Red wire is 12V and blue wire is Ground.

Important!

There is no **fuse** built in the system, obligatory use 3A external fuse. **Never remove the CAN BUS Terminator**, which occupies one CAN port (factory pre-set). Terminator should only be removed in case of second seat configuration. **In that case the terminator should be positioned on second seat unit.**

A 2-pole plastic power connector, which is positioned approximately 20 cm from the unit casing ensures simple disassembling of the unit in case of repair.

14.3.1 Installation of USB D 60 (Vario unit)

The USB D 60 unit comes with prefabricated cable set, which has two connectors. The 15-pole type should be inserted into the vario unit and should be secured with the appropriate spring locks. The 9P connector should be inserted into any free 485-marked plug on Zeus back. The unit also receives its power from Zeus. Speaker output is terminated with one chinch female connector; a male connector is part of the speaker.

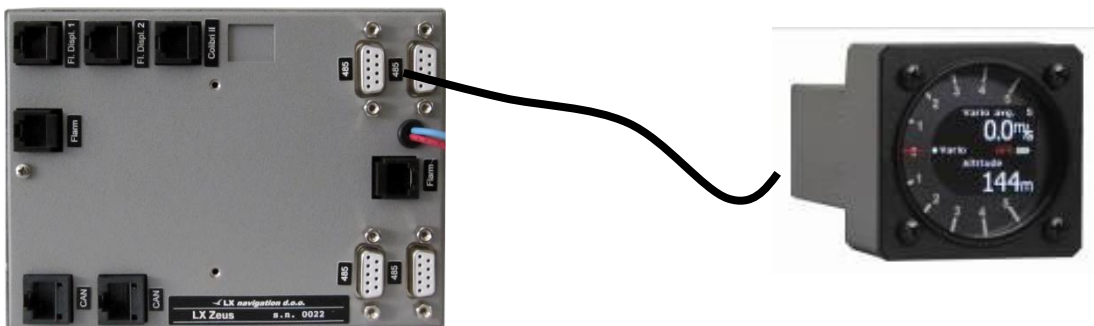

CAN terminator can be inserted either into the left or right CAN PORT = Not important.

9P (485 system bus) can be connected also to any free 485-connector plug.

14.3.1.1 USB-D 60 wiring

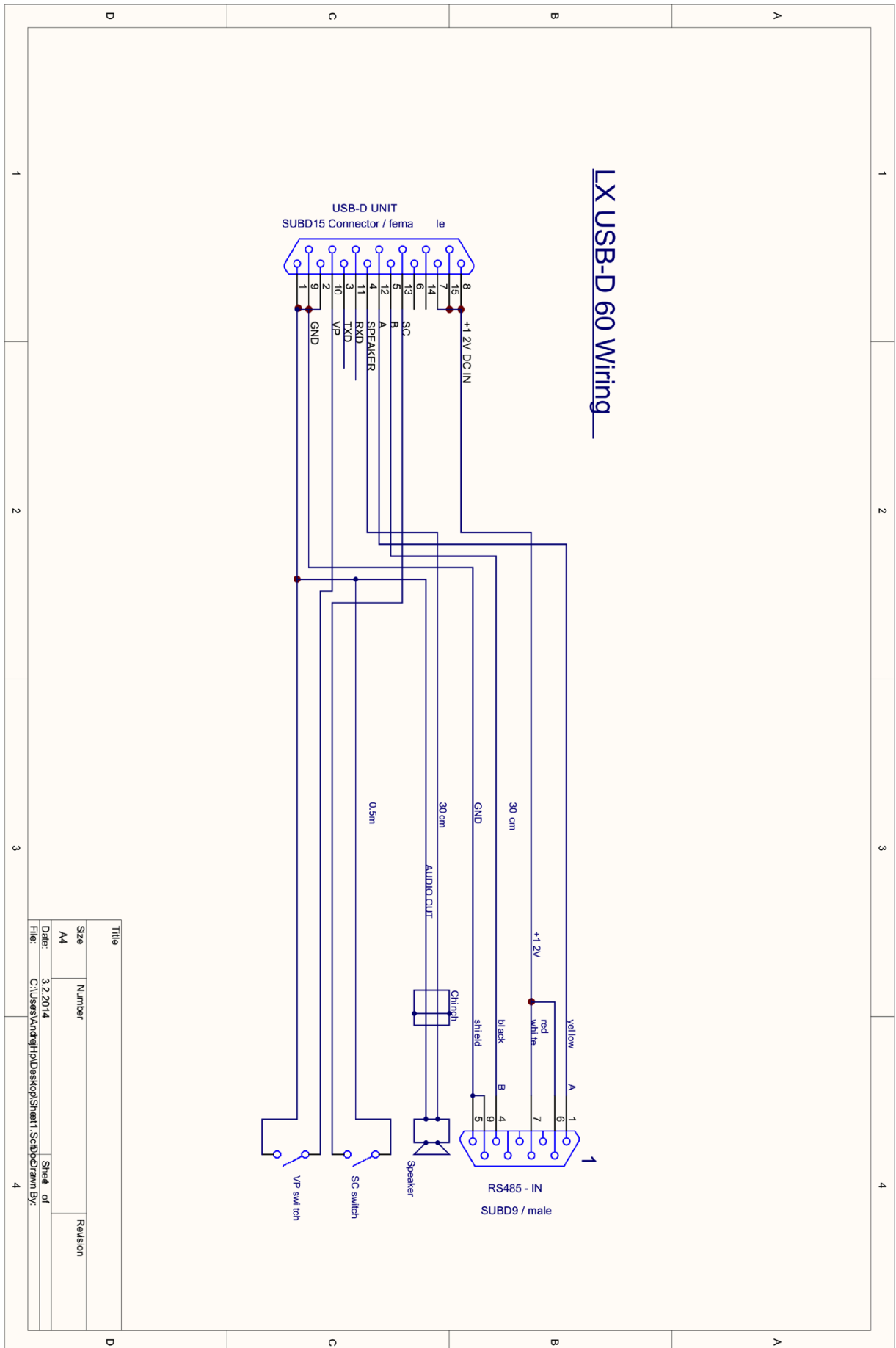

14.4 Installation of second seat units

The second seat unit shares the same logic as the master, so no difference with mechanical installation works.

14.4.1 Electrical installation

The second seat unit doesn't need external power, as it is powered via the system bus (CAN). For CAN connection two 8P connectors are provided on master and also on repeater. The interconnection of both units is extremely simple and easy, all what is necessary is to insert CAN marked cable in one of two CAN marked plugs. The same is valid for first and for second seat. Second seat unit comes with two red wires, which are terminated with a toggle switch. It is recommended to install the switch somewhere in the rear panel, as this will make possible to switch off second seat unit during single pilot operation.



Note!
Never remove CAN terminator which occupies one CAN plug of the second seat unit.

Note!

Interfaces which interact with the second seat, should also be connected to second seat 485 bus:

- Remote control
- Vario indicators

Compass module, Voice module should be connected only to first seat and of course they will also work on the second seat!

15 Explanation of terms

Text explanations of NAV BOXes

Item	Description	NAV BOX designator
Above ground level	Altitude above ground level	AGL
Air temperature	OAT	Temp
Altitude IGC	Altitude recorded by flight recorder (1013 based)	Alt IGC
Altitude GPS	Altitude recorded by GPS	GPS Alt
Altitude QFE	QFE altitude based on approaching point	Alt QFE
Altitude QNH	Altitude over sea level	Alt QNH
Altitude QNH (ft)	Altitude over sea level in ft	Alt QNH
Analogue clock	Analogue clock symbol	Clock symbol
Arrival altitude	AGL height (+reserve) on arrival at selected TP	Arri Alt
Average vario	Integrator (average of last x seconds – set in SETUP / VARIO SC / Integration scale)	V Avg
Average netto vario	Average of air mass vertical movement during the whole flight	AVG netto
Battery	Battery symbol	Battery symbol
Bearing TP/APT/T	Bearing to TP/APT or TP of task	BRG
Circling radius	The radius of circling in a thermal	Circ Rad
Compass heading	Heading that is calculated from compass (if compass module is installed)	HDG
Cur. eff. TP/APT/TSK	Efficiency calculated during last time period	E
Compass Heading		HDG
Digital clock	Digital clock symbol	Time
Distance in NM to sel. TP/APT	Distance to TP/APT in NM	Dist NM
Dist. to sel. TP/APT	Distance to TP/APT	Dist
Empty	NAV BOX will remain empty	No designator
ETA (average speed)	ETA based on average speed reached	ETA Avg
ETA (current speed)....	Estimate time of arrival based on actual speed	ETA Sp
ETA MacCready speed	ETA based on MC setting	ETA MC
Final glide	Altitude difference regarding to f.g. line	FG
Final glide (MC 0.0)	Altitude difference regarding to f.g. line at MC 0.0	FG(MC 0.0)
Flight level	Actual flight level indication	FL
Flying time	Time spent in the air	Flying
GPS position	Indication of coordinates	Coordinates
GPS signal	GPS status symbol	GPS Symbol
Ground speed	Speed over ground	GS
Horizontal distance from airspace	Glider position horizontally from the airspace	AS hor
Indicated Air Speed	Airspeed not altitude corrected	IAS
Leg speed	Leg speed on task	Leg speed
Netto vario	Shows air mass vertical movement	V Netto
OLC	OIC point scored to current location	OLC
OLC home	OIC points that will be scored if takeoff position is reached.	OLC Home
OLC speed	Speed when flying a cross country flight under the rules of OLC	OLC sp
Off course distance	Off course indicator	Off co
Radial TP/APT	Radial from TP/APT to the glider position	QDR
Recommended flaps position	Recommended flaps at pre-set speed range	Flaps
Relative vario	Netto vario – 0.7	V relative
ETE – estimated time enroute	Remaining time to selected TP/APT or until end of TSK	ETE
Required eff. TP/APT.....	Required efficiency to reach TP/APT/TSK	Req E

Required speed	Required speed to finish AAT in time	Req Sp
Set MacCready	Actual MC setting	MC
Sink Speed	Estimated sink rate (polar, speed, bugs, MC)	Sink Sp
Task delta time	Early or late arrival on AAT	TDT
Task remaining distance	Distance to go until finish	Task RD
Task speed	Speed achieved on task	Task Sp
Team Bearing	Bearing to your team partner	Team BRG
Team Code	Coded location of your team partner	Team code
Team Distance	Distance to your team partner	Team Dist
Thermal all	Altitude gain during whole flight	Th All
Thermal average	Average climbing during last whole thermal (usable for MC setting)	Th Avg
Thermal gain	Altitude gained during last climb	Th Gain
Thermal last 30	Altitude gain during last 30 seconds of climbing	Th L30
Time on leg	Time spent on leg	On Leg
Time on task	Time spent on task	On Task
Time to go	Time until the end of TSK	TTG
Track TP/APT/TSK	Ground track to TP/APT or TP of task	TRK
True Air Speed	Airspeed corrected with altitude	TAS
Vario	Momentary variometer value	Vario
Vertical distance from airspace	Glider position vertically from the airspace	AS ver
Wind direction	Wind direction calculated by Zeus	Wind Dir
Wind speed	Wind speed calculated by Zeus	Wind Sp

16 Zeus Mobile

The unit is very similar to Zeus 4.3. Zeus Mobile is meant to be installed on the panel with a gooseneck – no panel upgrade is needed. It can also be installed as an integral part of the panel.

Zeus Mobile can be used for single seaters only. There is no double seater option.

Vario unit as a black box solution (doesn't occupy any space of the instrument panel), Zeus has the vario indicator as a part of the graphic page (custom design possible), but it can also be additionally ordered in either 57 mm or 80 mm vario indicator option.

Zeus Mobile also has two GPS inputs (Colibri II and NMEA).

At LX Junction box following units can be connected:

- LX Remote Stick
- GPS (Flarm, Colibri, Volkslogger, LX GPS mouse...)
- USB-D unit (vario black box)

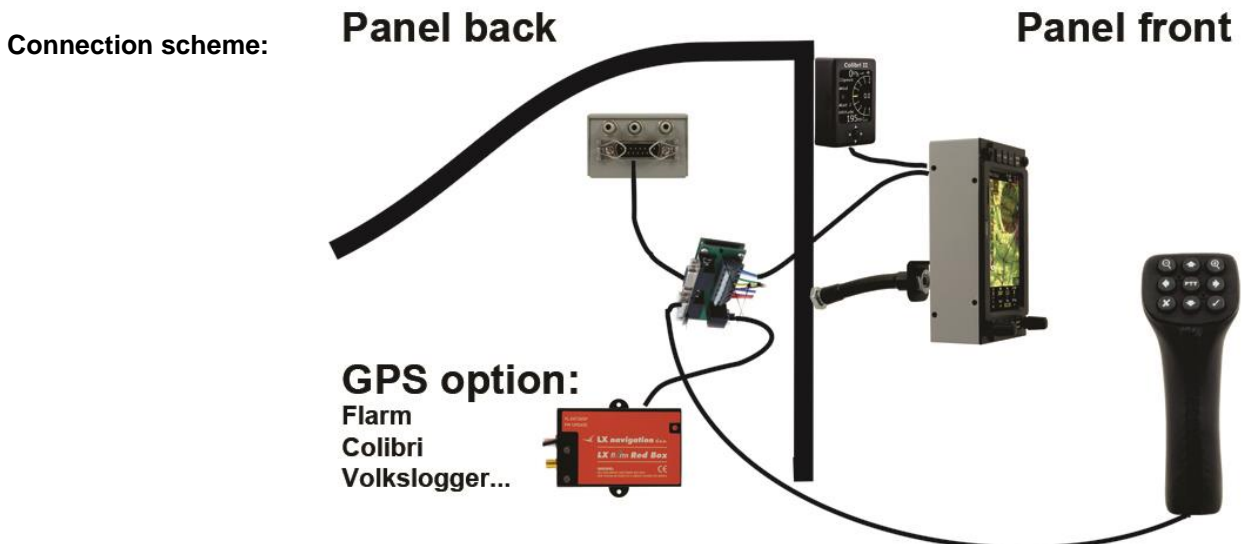

17 FAQ (frequently asked questions)

1. Can I connect Swiss Flarm and how will it work?

Flarm can be connected to LX Zeus NMEA (flarm) port. Zeus will see flarm objects and will send declaration to flarm (task and pilot's settings)

2. Volkslogger, Colibri and other loggers - how to connect and what is the advantage?

Loggers can be connected to NMEA (flarm) port. Zeus will take GPS signal from them and give them 12 V power.

3. What do I get if I buy LX ZEUS IGC FLARM

Zeus comes together with Vario, Speaker, Oat sensor, Colibri II, FLARM (not IGC) and Flarm LED display, USB key and SD card. You have also an option to take FLARM IGC.

4. Zeus shows Voltage .0.0 V?

Voltage is measured on Vario unit, so this means that there is a problem with connection ZEUS – Vario. Check connection – cable and both units.

5. Voltage – what is the operating Voltage?

LX Zeus operates from approximately 8 V to 16 V.

6. ADSB and Powerflarm on Zeus – how to connect, what kind of warnings, warnings with Voice modules?

ADSB can be simply connected to LX ZEUS on FLARM port. Zeus will provide all Flarm warnings – same as Flarm Red Box or Mini Box.

7. OUDIE – is it possible to connect, what cable, where to connect?

Only with a special cable in case that flarm unit is connected to LX Zeus.

8. AIRSPACE Warnings and a Voice module?

The voice module will also give voice-warnings for airspaces.

9. ENL and Zeus?

If an IGC Zeus is ordered, then the ENL sensor is the part of the system for FREE (built in Colibri II)

10. AHRS – is it adjustable so that it can be set on the ground?

Yes, of course. For explanation of the procedure, check the relevant chapter in this manual.

11. CONDOR simulator – can you connect Zeus and play with it?

Not possible by default (must be specified when ordered). There will be only GPS data, no baro data.

12. Can I use OAT sensor from LX 7007, LX 7007 C and LX 5000?

It is not possible.

13. Can I use remote from LX 5000, LX 7007 / C?

The Remote Stick can be used from LX5000 (not valid for keyboard), 7000, 7007 and 7007 C. Only the button-descriptions have changed with the new Zeus functions. A rubber can be changed to modify the buttons. This can be done by the user.

14. Why does LX Zeus restart when I switch from battery 1 to battery 2?

You are probably using the wrong switch. You must not use a switch, which cuts off power for a short period when you change from battery 1 to battery 2. You should use a switch that always lets the current through to Zeus.

15. How to do a system reset (completely delete the software and install in again)

- Push on zoom rotary switch,
- Go to setup,
- Go to Admin password
- Enter password: 49046 and push on zoom rotary switch (this will dele the software)
- To install the software do as is instructed in chapter 3 Update procedure.

16. I am having problems with the communication between the primary Unit and the secondary Unit on my double seater, what can I do?

First check if the Zeus unites are connected. This is done by a long press on Setup/info button. In the Info window, there should be a sign either primary unit or secondary unit.

If there is no sign do a system reset on the secondary unit as is explained on the previous answer. When the installation of the software is done, a message will appear, asking you if this is the primary or secondary unit. Select secondary unit.