

LX

navigation

LX10K user's manual



LX 10k



Device manual

- LX navigation -

July, 2020



Tkalska ulica 10
SI-3000 Celje
Tel.: 00 386 3 490 46 70
Fax.: 00 386 3 490 46 71
info@lxnavigation.com
www.lxnavigation.com

Document information

0.1 Abstract

This document represents the user manual for the LX 10k vario-navigation system. The installation manual, dataport and additional info can be found on www.lxnavigation.com.

0.2 Document status

Document status: PUBLIC

Document status	Explanation
Internal	Intended only for LX navigation staff
Public	Available publicly to all
Personal	Intended for a specific person and/or company, noted on this page
Dealer	Intended for a specific dealer, noted on this page
Manufacturer	Intended for a specific manufacturer, noted on this page

0.3 List of applicable products

Device	Version	Build
LX 10k w/ analog indicator	V1.6	151
LX 10k w/ digital indicator	V1.6	151

0.4 Revision history

Document name	Document revision	SW version	Date	Revised by	Approved by	Notes
LX_10KUM	R1	1.6	27.7.2020	L.R.	N.S.	LaTeX release

Contents

0	Document information	3
0.1	Abstract	3
0.2	Document status	3
0.3	List of applicable products	3
0.4	Revision history	3
1	Important notices	8
1.1	Using this manual	8
1.2	Device operating limits	8
1.3	Limited warranty	8
1.4	Sunburned display	9
1.5	Disclaimer/EULA	9
2	Getting started	10
2.1	Device overview	10
3	Basic operation	13
3.1	Turning the LX 10k on	13
3.2	Device interface	14
3.3	User input	15
3.3.1	Right push-rotary knob (PAGES)	15
3.3.2	Left push-rotary knob (ZOOM)	15
3.3.3	Right push button (MC)	15
3.3.4	Left push button (BOX)	15
3.4	Performing an update	16
3.5	Turning the LX 10k off	17
3.6	Turning the indicator ON and OFF	17
3.7	A word on internal battery and flight mode	17
4	Advanced operation	19
4.1	Navigation pages	19
4.1.1	The map	20
4.1.2	The Header	21
4.1.3	The Wind indicator	21
4.1.3.1	The Final glide indicator	22
4.1.3.2	The NavBox line	22
4.1.3.3	Status indicators	24
4.1.4	Turnpoint navigation page	26
4.1.4.1	Choosing a Turnpoint	28
4.1.5	Airport navigation page	29
4.1.6	Task navigation page	31

4.1.7	Nearest landable navigation page	36
4.1.8	GPS DATA INVALID	37
4.2	Thermal assistant page	38
4.3	Flarm radar page	40
4.4	AHRS page	43
4.5	G-force page	45
4.6	Info page	47
4.7	Logbook/Flight statistics page	48
4.7.1	Logbook	48
4.7.2	Flight statistics	49
4.8	Airspace page	51
4.9	Setup page	52
5	Device setup	53
5.1	User settings	53
5.1.1	Pilot	53
5.1.2	Vario/SC	55
5.1.3	Task	56
5.1.4	Indicators	56
5.1.5	Voice	59
5.1.6	Pages	59
5.1.7	Graphics	59
5.1.7.1	Airspace	60
5.1.7.2	Map	60
5.1.7.3	Task	62
5.1.7.4	NavBox settings	62
5.1.7.5	Theme	63
5.1.8	Warnings	64
5.1.9	Logger	64
5.2	System settings	66
5.2.1	Glider	66
5.2.2	Units	67
5.2.3	NMEA	68
5.2.4	Inputs	69
5.2.5	Transfer	70
5.2.5.1	Turnpoints	71
5.2.5.2	Airports	71
5.2.5.3	Airspace	72
5.2.5.4	Load task	72
5.2.5.5	Flarm NET	72
5.2.6	Network	73
5.2.7	Localisation	74
5.2.8	Synchronisation	74
5.2.9	Service	75
5.2.9.1	Club mode	76
5.2.10	Shutdown	76

6	Connectivity	77
6.1	WiFi connectivity	77
6.1.1	Flight transfer	77
6.1.1.1	Setting up an email address	77
6.1.1.2	Establishing a WiFi connection	77
6.1.1.3	Sending the flight	78
6.2	Bluetooth connectivity	78
6.2.1	Connecting an Android device (XC soar)	78
6.2.1.1	Establishing a Bluetooth connection	78
6.2.1.2	Setting up the LX 10k	79
6.2.1.3	Setting up XC Soar	79
6.2.2	Connecting an Oudie or other PNA/PDA device	79
6.2.2.1	Establishing a Bluetooth connection	79
6.2.2.2	Setting up the LX 10k	80
6.3	User port connectivity	80
6.3.1	Connecting an Oudie	81
6.3.2	Connecting a Radio	81
7	Vario Indicator Unit	82
7.1	The digital vario unit	83
7.1.1	Main page	83
7.1.1.1	Digital needle scale	83
7.1.1.2	Digital numeric indicators	85
7.1.1.3	Current time and OAT	85
7.1.1.4	Flarm status indicator	86
7.1.1.5	Connectivity status indicator	86
7.1.1.6	GPS status indicator	86
7.1.1.7	Flight mode status indicator	87
7.1.1.8	Battery status indicator	87
7.1.1.9	Wind indicator	87
7.1.1.10	Volume setting	88
7.1.2	Thermal assistant page	89
7.1.3	Vario setup page	90
7.1.3.1	Graphics	90
7.1.3.2	Thermal assistant	92
7.1.3.3	Service	92
7.1.3.4	Shutdown	92
7.2	The analog vario unit	93
7.2.1	Volume setting	93
7.2.2	Mechanical needle	93
7.2.3	Digital indicators	94
7.2.4	Status indicators	94
7.2.4.1	Wind indicator	94
7.2.4.2	Flarm status indicator	94
7.2.4.3	GPS status indicator	94
7.2.4.4	Flight mode status indicator	95

7.2.4.5	Battery status indicator	95
8	LX Joy	96
9	Taking care of your LX 10k	98
9.1	The internal battery	98
9.2	Pressure sensors	99
9.3	Display	99
9.4	Device housing	99
9.5	RJ connectors	99
9.6	MicroSD card reader	100
9.7	Reverse polarity on power	100
10	Release notes	101
10.1	1.6.151/6508 (2020-07-14)	101
10.2	1.6.142/6504 (2020-07-06)	101
10.3	1.6.136/6495 (2020-07-02)	101
10.4	1.6.119/6478 (2020-06-15)	101
10.5	1.6.112/6457 (2020-06-10)	102
10.6	1.6.110/6453 (2020-06-08)	102
10.7	1.6.102/6446 (2020-06-02)	102
10.8	1.6.100/6441 (2020-06-02)	102
10.9	1.6.90/6423 (2020-05-27)	102
10.10	1.6.86/6410 (2020-05-25)	102
10.11	1.6.70/6381 (2020-05-12)	102
10.12	1.6.49/6367 (2020-05-07)	102
10.13	1.4.29/6345 (2020-04-28)	103
10.14	Automated builds (from 2019-06-17 to 2020-04-06)	103
10.15	Version 1.0.10 (2019-03-08)	104
10.16	Version 1.0.04 (2019-01-25)	105
10.17	Version 0.5 (2018-11-14)	105
10.18	Version 0.3 (2018-10-01)	105
10.19	Version 0.2 (2018-09-07)	105
11	Contact	106

Important notices

1.1 Using this manual

This manual has been created in \LaTeX , giving us the possibility of linking up everything we find linkable. You will find references to other parts of the manual, to other manuals, webpages, etc. throughout the manual.

Linkable content will be **bold and underlined**, i.e. you can find additional info on how to take care of your LX 10k in the **Taking care of your LX 10k** section of this manual (click on the underlined text).

NOTE

The most recent version of this manual will always be available at
<http://lxnavigation.com/downloads/manuals/Eos/LX-10k-fresh.pdf>

1.2 Device operating limits

This instrument may be used under VFR (Visual flight rules) only! Any navigational information is provided for reference only. The pilot takes all responsibility and risk associated with the use of this device.

Have a nice flight.

1.3 Limited warranty

This device is warranted to be free from defects in materials or workmanship for two years from the date of purchase. Within this period, LX navigation will, at its sole discretion, repair or replace any components that fail in normal use. Such repairs or replacements will be made at no charge to the customer for parts and labour, the customer shall be responsible for any transportation cost. This warranty does not cover failures due to abuse, misuse, accident, or unauthorized alterations or repairs.

THE WARRANTIES AND REMEDIES CONTAINED HEREIN ARE EXCLUSIVE AND IN LIEU OF ALL OTHER WARRANTIES EXPRESSED OR IMPLIED OR STATUTORY, INCLUDING ANY LIABILITY ARISING UNDER ANY WARRANTY OF MERCHANTABILITY OR FITNESS FOR A PARTICULAR PURPOSE, STATUTORY OR OTHERWISE. THIS WARRANTY GIVES YOU SPECIFIC LEGAL

RIGHTS, WHICH MAY VARY FROM COUNTRY TO COUNTRY. IN NO EVENT SHALL LX NAVIGATION BE LIABLE FOR ANY INCIDENTAL, SPECIAL, INDIRECT OR CONSEQUENTIAL DAMAGES, WHETHER RESULTING FROM THE USE, MISUSE, OR INABILITY TO USE THIS PRODUCT OR FROM DEFECTS IN THE PRODUCT.

Some countries do not allow the exclusion of incidental or consequential damages, so the above limitations may not apply to you. LX navigation retains the exclusive right to repair or replace the unit or software, or to offer a full refund of the purchase price, at its sole discretion. SUCH REMEDY SHALL BE YOUR SOLE AND EXCLUSIVE REMEDY FOR ANY BREACH OF WARRANTY. To obtain warranty service, contact your local LX navigation dealer or contact LX navigation directly.

1.4 Sunburned display

Damages to the device, especially the display part, are not covered by the warranty and will be considered as misuse of the device. To learn how to take care of your display and device in whole, check the [Taking care of your LX 10k](#) section of this manual.

1.5 Disclaimer/EULA

LX navigation reserves all rights to this document and the information contained herein. Products, names, logos and designs described herein may in whole or in part be subject to intellectual property rights. Reproduction, use, modification or disclosure to third parties of this document or any part thereof without the express permission of LX navigation is strictly prohibited. The information contained herein is provided "as is" and LX navigation assumes no liability for the use of the information. No warranty, either express or implied, is given, including but not limited, with respect to the accuracy, correctness, reliability and fitness for a particular purpose of the information. This document may be revised by LX navigation at any time. For most recent documents, please visit www.lxnavigation.com or contact info@lxnavigation.com. Copyright © 2020, LX navigation d.o.o.

Getting started

2.1 Device overview

The LX 10k is a glider vario-navigation system, that comprises of two devices. The main unit - the LX 10k, which is always in the **80mm (3 1/8 inch)** size and the vario indicator. The vario indicator comes in three different options:

- **57mm (2 1/4 inch) analog vario indicator** - comes with the 10k as standard, features a small (1.77 inch) display and an analog needle.
- **57mm (2 1/4 inch) digital vario indicator** - option over the analog indicator, has a larger 2.5 inch display and a digital needle
- **80mm (3 1/8 inch) digital vario indicator** - option over the analog indicator, has a large 3.5 inch **transflective technology** display, same as the main unit.

NOTE

Find out more about transflective technology displays and why this technology is so important in air navigation in our [Whitepaper on transflective technology](#)

The LX 10k is a navigation device with moving map, electronic variometer, IGC certified logger with ENL, a built-in battery, Voice module with voice warnings, Bluetooth and Wifi and the possibility of a cable connection to external devices.

Find the IGC approval [here](#).

The device is designed for simple pilot operation with two push-buttons and two push/rotary knobs on the main unit and one push-rotary knob on the indicator unit.

The unit is capable of providing APT (airport), TP (turnpoint), TSK (task) and NRST (nearest landable) navigation on four dedicated navigation pages. Navigation pages feature navboxes, showing bearing to point, track, distance and final glide as well a large selection of other flight and navigation parameters. It also shows airspace, airports and turnpoints on the map.

LX 10k has built-in high precision digital sensors based on latest MEMS technology for altitude, vario, speed, 3-axis gyro and 3-axis accelerometer sensors. A minimum sampling rate of 100 Hz is applied to all sensors.

A double-seater installation is possible by installing an LX 10k Repeater and connecting it to the system via CAN bus.

An integral IGC approved flight recorder with ENL level detector will record the flight to internal solid-state memory (16GB). All flights can be copied to an external SD card after flight.

The LX 10k has terrain information of the complete world. This terrain elevation information is used for generating simple terrain elevation colour maps, with different colour pallettes available.

For backup and safety reasons, it has an internal battery, that will provide power to the LX 10k for three to five hours after the main power supply is disconnected. An integral charger will charge the backup battery when external power supply is connected (12V).

LX 10k features are:

- 3.5 inch transfective technology sunlight readable display on the main unit
- 2.5 inch or 1.77 inch display (for the 57 mm version)
- Integrated G-meter (g-forces recorder)
- 3-axis gyroscope
- 3-axis accelerometers
- 50ch GPS receiver as an integral part of the system
- Completely new design using latest pressure transducers technology
- Extremely fast vario data acquisition
- Rotary knobs with push functions, for simple and effective handling
- Nearly unlimited memory space for flight recorder
- ENL (Environment Noise Level) sensor
- 5 user defined status inputs (SC, VP, gear, brakes and ballast)
- OAT probe input (outside air temperature)
- Internal beeper (for Flarm warning)
- Flarm port (input of Flarm data)
- User port for PDA/PNA/Radio/transponder, supplies navigation and Flarm data to PNA/PDA
- WiFi interface
- Bluetooth interface
- Voice module as an integrated part of the system
- CAN Bus, for connection to LX Zeus or other LX devices.
- External SD Card interface, for firmware updates, flight downloads and TP/TSK/AP-T/Airspace transfers
- Standard 80/57 mm size
- Built-in rechargeable battery provides three to five hours of autonomy
- Internal battery is charging whenever connected to main power
- Pre-loaded polar database

Functions:

- Variometer, TE compensation (TE probe or electronic compensation).
- Speed-to-fly function
- Final glide calculator based on GPS data (for TP, APT, TSK and NRST)

- Complete TP/APT/TSK, NRST navigation with airspace information and warnings
- Highest level IGC approved flight recorder (find the IGC approval [here](#))
- Flarm radar screen
- Thermal assistant screen
- System extensions: Second seat configuration, Remote control operation (LX Joy)
- Logbook
- Flight information with Barograph
- Multi pilot support
- Accurate wind calculation in straight flight and circling
- Voice announcement
- User warnings

The term "back-up mode" will be used in this manual to define the situation where main power is lost in flight. The LX 10k will use its internal backup battery to continue working. All functions of the LX 10k are operational in backup mode so the pilot can safely navigate back to home or complete the task.

The unit has the capability of being updated to any later firmware release free of charge.

Basic operation

We will go through the basic gestures and what they do on all pages of the LX 10k system. The first part of this manual will go through the control of the main unit, while in the end, we will go through controlling the vario indicator.

One important thing to keep in mind is that there are usually multiple ways of doing something on an LX 10k and, although we will go through all of the possibilities, the LX 10k is envisioned to be used single-handedly and almost all operations are accessible with the right push-rotary knob. Bearing this in mind and getting used to doing all operations with the right push-rotary knob will greatly elevate your user experience.

3.1 Turning the LX 10k on

The **LX 10k** is turned on by pressing and holding the left push-rotary knob (**ZOOM**) until the screen flashes.

Once the device is turned on, a sequence of screens will appear in the following order:

- **LX navigation greeting screen**
- **Second screen** stating the device type, serial number, IGC number and firmware version
- **The initial setup** page will appear, where basic information is selected:
 - **Select pilot**, where a pilot profile should be selected, from which all user settings shall be imported
 - **Set elevation**, where the elevation of the take-off location should be selected
 - **Set QNH**, where the QNH pressure should be set for take-off location

WARNING

When the device is turning on, three types of warnings may appear, indicating limited operation capability to the pilot. In first two cases, recording is disabled and you should contact **LX support** as soon as possible. In all three cases, the system will offer navigation.

- **Seal not valid** - indicates the internal IGC seal of the device has been lost. Explained in detail in section **The internal battery**.
- **Internal memory error** - there is an issue with the internal memory of the device. Flights will not be saved and settings will not be loaded, but the device will operate.
- **Network module error** - indicating an issue with the internal network module.

3.2 Device interface

The LX 10k features two push buttons and two push-rotary knobs for pilot-device communication. The front side of the device, represented by figure 1, shows the LX 10k's user input interface.

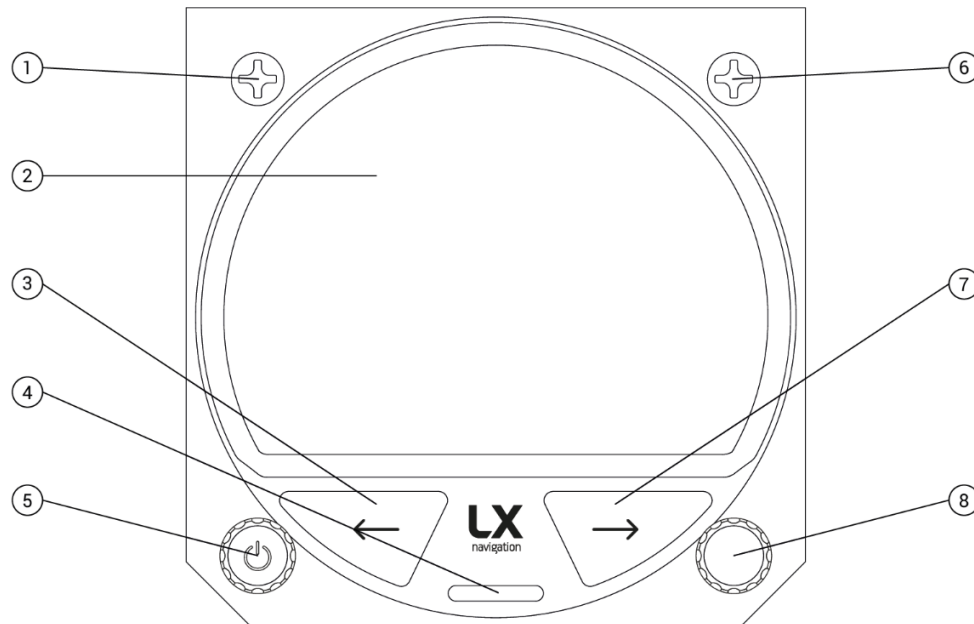

Figure 1. LX 10k front plate interface

On the front plate, we can see the following items:

- | | |
|------------------------------------|--|
| 1. M4x6 Phillips head screw | 5. Left push-rotary knob (ZOOM) |
| 2. LX 10k display | 6. M4x6 Phillips head screw |
| 3. Left push button (BOX) | 7. Right push button (MC) |
| 4. microSD card reader | 8. Right push-rotary knob (PAGES) |

We will name the two main push buttons and two main push-rotary buttons by their function (**ZOOM**, **MC**, **BOX**, **PAGES**). The push-rotary knob on the LX 10k indicator will be named by its function - (**VOL**).

3.3 User input

The LX 10k was envisioned to be simple and intuitive to use. There are two buttons and two push-rotary buttons mentioned in the previous sub-section.

The LX 10k can also be commanded by an LX Joy. Learn more in the [LX Joy](#) section of this manual.

3.3.1 Right push-rotary knob (PAGES)

The right push-rotary is used for the following functions:

- **Changing between primary pages**, clockwise for next, counter-clockwise for previous.
- **Scrolling**, turn clockwise for moving down, right or for choosing larger values, counter-clockwise for moving up, left or changing by smaller values.
- **Turning while being pressed**, acts as noted above, **by 10-fold**.
- **Pressing**, acts as '**Confirm**', '**Enter**'
- **Holding it**, while in a navigation page, will open the '**NavBox select**' sub-page

3.3.2 Left push-rotary knob (ZOOM)

The left push-rotary is used for the following functions:

- **Zooming**, turn clockwise to zoom in, counterclockwise to zoom out
- **Scrolling**, moving down, right or for choosing larger values, clockwise for moving down or changing by larger values, by 10-fold
- **Pressing**, acts as '**Cancel**', '**Exit**'
- **Turning while being pressed**, acts as noted above, by **100-fold**.

3.3.3 Right push button (MC)

The right push button is used for opening the MC sub-page, which gives us the MC sub-page, while in any primary page. This page can be used for setting, **Volume**, **MacCready**, **Ballast**, **Bugs**, **QNH** and **Brightness**.

3.3.4 Left push button (BOX)

The left push button is used for changing the **NavBox** lines on all four navigation pages. Holding it will open the '**NavBox select**' sub-page, and pressing it will slide through the three dedicated **NavBox** lines and hide it with the fourth click.

3.4 Performing an update

In order to be on track with the latest software releases, be sure to regularly follow our **Database webpage**. Once you find an update, contact LX navigation support via the following email: info@lxnavigation.com with your contact details, device type, the software version you would like to update to and the serial number of your device. The support staff will provide you with an update code.

Once you have received the update code, follow these steps:

1. Copy the desired software update file to the root of the microSD card. The update file should have the word 10k within its name and an extension of .lxu. Be sure to use the supplied SanDisk Ultra microSD card.
2. Insert the microSD card and turn the device on
3. Go to **Setup > Service > Software update**
4. Select the desired update file
5. When prompted, type in the update code supplied by LX support
6. The device will copy the file to the internal memory and perform the update. It may restart a couple of times.
7. Once the update has finished, verify that the update has been successful by going to **Setup > Service > Device info** and checking that the SW version has changed to the desired one

NOTE

The LX 10k will shut down during the update procedure and will require the right push-rotary knob to be pressed in order to turn it on after the file has been copied, in order for the update process to proceed.

WARNING

Once the LX 10k has been updated, it will update the indicator and all other CAN-compatible devices (LX Joy, second seat device, etc). For this reason, the LX 10k should be left ON for at least five minutes after the main unit has been successfully updated. If the update of CAN units is ongoing, an infobox will appear, notifying the pilot. While this infobox is active, the unit should not be used.

WARNING

Great care should be taken not to turn the device off while the updating process is running. Data corruption may occur. If something similar happens, contact LX support immediately, in order to recover your unit.

3.5 Turning the LX 10k off

The LX 10k can be turned off in different ways, depending on the configuration you have.

All units will start the shutdown process once the power supply is cut from the main power lines, unless in flight mode.

There is a possibility of a manual shutdown by going to **Setup > Shutdown** and confirming by choosing 'Yes'.

In case a device requires a **force shutdown**, there is a possibility of performing a **hard shutdown by pressing and holding the ZOOM push-rotary knob for 10 seconds**.

3.6 Turning the indicator ON and OFF

In all cases of normal operation, the LX 10k vario indicator (be it analog or digital) requires no special handling in order to turn on or off.

The indicator will turn on automatically once the main unit has been turned on, and will shut down once the main unit has been shut down.

If one wishes to perform a **hard shut down of the vario indicator**, it can be done by pressing and holding for 10 seconds the **push rotary knob on the vario indicator**.

3.7 A word on internal battery and flight mode

All LX 10k devices (including the vario indicator) have a built-in reserve battery, intended for supplying the unit with power in case your aircraft loses its main power supply. The reserve battery is not intended for use on the ground, which is why the device can not be turned on, on reserve battery alone.

Flight mode is a term describing a state in which the LX 10k is, when the device detects it is flying. For getting into flight mode, one of the following parameters must be met:

- **GPS lock** is present, and
- **GPS speed** is above 10 m/s, or
- **airspeed** larger than 10 m/s is present, or
- **significant movement in vertical speed**

Once in flight mode, the LX 10k will not turn off if the main power supply is cut, but continue operating as long as there is internal power, or until the main power supply is reestablished. The internal battery powers all of the internal features of the LX 10k, which covers everything described in this manual. The LX 10k will continue logging, with IGC seal intact, it will continue providing you vario information, sound warnings, complete navigation, etc.

External modules, such as Flarm, Flap sensor, Joy, etc. will not work, as they require the main power supply.

If you wish to turn the LX 10k off, while in flight mode, you will have to exit the flight mode by going to **Logbook/Flight statistics page**, press the right push-rotary (**PAGES**) knob and confirm the 'Finish flight' question. The LX 10k will check the integrity and seal the flight and turn off, if no external power is present.

A sure way of knowing if the LX 10k is in flight mode is to go to the Statistics/Logbook page. If the Statistics page is present, with the altitude barograph present, the LX 10k is in flight mode.

You can simulate flight mode, while on the ground, by receiving a GPS lock and applying slight dynamic pressure to the P_{TOT} pressure port (or front entrance of Pitot tube), so the IAS is above 10 m/s for about 5 seconds. You can keep the LX 10k in flight mode by then disconnecting the GPS antenna, or by keeping the IAS constantly above 10 m/s.

For notes on how to take care of your LX 10k's reserve battery, check the **Taking care of your LX 10k** section of this manual.

WARNING

Great caution should be exercised when applying pressure for IAS simulation, as the internal pressure sensor of the LX 10k, and other avionics, may get damaged if excessive pressure is applied, water is present in the Pitot-static system, or similar. LX navigation is in no case liable for any damages that may appear when simulating and strongly discourages simulating flight mode while grounded.

However, if a simulation has to be done, the steps above are the safest.

Advanced operation

Primary pages overview

This section will cover the complete specter of operations possible on LX 10k's primary pages.

There are 12 primary pages on the LX 10k. You can scroll between these pages by using the right push-rotary knob (**PAGES**). The pages are listed as follows:

1. Turnpoint navigation page
2. Airport navigation page
3. Task navigation page
4. Nearest landable navigation page
5. Thermal assistant page
6. Flarm radar page
7. AHRS page
8. G-force page
9. Info page
10. Logbook/Flight statistics page
11. Airspace page
12. Setup page

4.1 Navigation pages

The LX 10k offers 4 separate navigation pages, giving the pilot simultaneous navigation to a **turnpoint**, **airport**, over a **task** and to the **nearest landable point**.

The basic layout of each navigation page is the same. In the top of the page, we can see the header. Below the header, we can see the moving map, the wind indicator on the left and the final glide indicator on the right. Above the final glide indicator, a zoom scale is positioned and in the bottom of the page, the NavBox line is positioned.

Pressing the **left push-rotary knob** will show additional info for the point we're currently navigating to on the **turnpoint**, **airport** and **nearest landable page** and open additional task options on the **task navigation page**. Rotating the left push-rotary will change the zoom level.

Pressing the **left push button** will initiate NavBox line commands. A short press will change between 3 different NavBox lines, and a long press will initiate the '**Select NavBox**' dialog.

Pressing the **Right push button** will open the MC (MacCready) sub-page on the volume parameter. Pressing the right push button again will change to the next MC parameter, in the following order:

- **Volume** – > **MacCready** – > **Ballast** – > **Bugs** – > **QNH** – > **Brightness**

While the MacCready sub-page is open, the status indicator line can be seen in the top of the display. The status indicators are also present at all times on the **Vario Indicator Unit**. You can exit the MC sub-page by cycling through all of the settings, by pressing the left push-rotary knob, or by waiting. Namely, the MC subpage closes automatically after 3 seconds of inactivity.

Pressing the **right push-rotary knob** will open additional settings for the current setup page. The contents of the additional setting sub-page depends heavily on which navigation page we're on and will be explained for each page individually later.

4.1.1 The map

The Turnpoint navigation page is based on a map, covering the central part of the screen. The map shows simplified **terrain elevation** by colour gradation (different colour palettes available in the **Graphics** section), airspace lines, turnpoints and airports. The map also shows **turnpoints and airports** with small circles and their names, as well as **airspace lines**.

On the Map, a glider icon represents your current location. The LX 10k supports both North-up and Track-up orientation, which can be set in the **Graphics** section.

On the far-left of the map, a **wind indicator** is shown. On the right, a **final glide indicator** is shown with the map scale.

Two lines can be seen on the screen, starting at the glider. The first one is showing the



Figure 2. A navigation page

direction of your movement, your track, and the second one is showing the direction to your chosen turnpoint, the destination line. Colours can be changed in the **Graphics** setup menu.

On the map, a red/blue line, known as the **TAIL** is drawn behind the glide, marking your previous positions. The blue colour indicates the glider experienced sink in that point, while the red colour indicates it has experienced lift. The width of the line indicates the strength of the lift/sink. The wider the line, the stronger the lift/sink. This can help the pilot center the thermal more quickly, as he can see the exact mapping of thermal strength on the map.

4.1.2 The Header

The Header represents the top part of the screen, covering three vital pieces of information: **Turnpoint name, Relative bearing** and **distance** to turnpoint.

In the far top of the screen, we can see '**TP:**' written. The **TP** indicates that we are on the **Turnpoint navigation page**. After the colon, the name of the turnpoint to which we are navigating to is displayed.

To the lower left of the turnpoint name, relative bearing is shown in degrees. When the relative bearing is 0, we are flying towards the turnpoint.

Since the relative bearing is calculated from the bearing to turnpoint and your current **track** (not heading), **the wind is already calculated into the relative bearing**.

On either side of the relative bearing, a green arrow will show in which direction you should turn by the noted amount of degrees in order to be on course for the turnpoint.

To the lower right of the turnpoint name, distance is shown, in the desired distance unit.

4.1.3 The Wind indicator

The wind indicator is located on the far left side of the main unit display, above the NavBox line. It shows three important wind parameters. Firstly, it shows the wind direction relative to our current track, with the black/green arrow indicator shown by figure 97. Absolute wind direction and wind speed is written in digits, to the left of the arrow. For info on how to set units, check the **Units** setup menu.



Figure 3. Wind relative direction indicator
(in this case showing direct headwind)

The wind is being calculated both in **circling** and in **straight flight**. It will update at all times and no settings are required.

4.1.3.1 The Final glide indicator

The Final glide indicator is an indicator located opposite of the wind indicator, on the far right of the map, above the NavBox line. It displays the Final Glide for the set MC value. The MC value is displayed above the Final Glide value, in white lettering. If you are within final glide, and your arrival altitude is positive, the final glide will be written in green. If you are not within final glide, your final glide will be written in red.

Once final glide is established, the LX 10k will notify you with a Voice notification over the speaker, stating: 'Final glide established'.

4.1.3.2 The NavBox line

In the lower part of the screen a **NavBox line** containing 4 NavBoxes is shown. The pilot can set-up up to three separate NavBox lines with his/her own NavBox preferences. Usually pilots set one NavBox line for **aerodrome gliding**, one for **racing tasks** and one for **AAT tasks**.

Pressing the **(BOX)** push button will swipe through these NavBox lines. If the **(BOX)** push button is pressed after the third line of navboxes, the navbox line will disappear, giving the pilot a larger and clearer representation of the map. Press the **(BOX)** push button again, for the NavBox line to reappear.

Holding the **(BOX)** push button, or holding the **(PAGES)** push-rotary knob for three seconds will start the 'Select NavBox' procedure. The navbox's black background will turn red, and the pilot can now choose which navbox he would like to change. Once the desired navbox position has been chosen, he can press enter **(PAGES)** and a list of available NavBoxes will appear. From the list, he can select a navbox he wishes and confirm it by pressing enter.

The following NavBoxes are available:

- **UTC time**
- **Local time**
- **Flight time**
- **Altitude**
- **IGC altitude**
- **Flight level**
- **Density altitude**
- **GPS altitude**
- **Height AGL**
- **Elevation**
- **Alt. QNH [ft]**
- **Vario**
- **Vario AVG**
- **Vario netto**
- **Vario relative**
- **TAS**
- **IAS**
- **Ground speed**
- **True track**
- **Distance**
- **Final glide**
- **Speed to fly**
- **Bearing**
- **Task time elapsed**
- **Task time left**
- **Current efficiency**
- **Require efficiency**
- **Thermal max**
- **Thermal average**
- **Eff. thermal avg.**
- **Thermal gain**
- **Circling radius**
- **OAT**
- **ENL**
- **G-force**
- **Flap position**
- **Rec. flap position**
- **Phase of flight**
- **No of landings**
- **Last landing time**

Since most of the indicators are self-explanatory, we will cover the ones that are not.

IGC altitude - altitude displayed by the internal IGC pressure sensor, which is not offset by QNH changes.

Density altitude - the density altitude is the altitude relative to standard atmospheric conditions at which the air density would be equal to the indicated air density at the place of observation.

GPS altitude - altitude displayed by the internal GPS module.

Height AGL - height above ground level = Actual altitude minus ground elevation.

Elevation - elevation of the ground above the mean sea level.

Vario AVG - average vario calculated by integration according to given settings (the same navbox is shown also on [Thermal assistant page](#) - AVG).

Vario netto - the actual vertical speed of the surrounding air mass. Is calculated by adding the current vertical speed indicated by the variometer, and the sink rate of the glider at that speed. Sink rate of the glider is calculated from the polar.

Vario relative - is Vario netto minus 0.7 [m/s] (subtracted for 0.7).

True track - true track based on GPS data.

Task time elapsed - shows elapsed time from starting a task.

Task time left - shows time left on task. Applicable only on AAT tasks.

Current efficiency - your current glide ratio, calculated by dividing your ground speed by your vertical speed.

Req. efficiency - required glide ratio for arriving on set navigation point (includes reserve altitude).

Thermal max - the maximum variometer value in the last circle (360 degree turn). This is the same value as is represented by white dot on TA page.

Thermal average - average vario calculated as: $\Delta(\textit{altitude}) / \Delta(\textit{time in circling})$ (same navbox on TA page - T AVG).

Eff thermal avg. - $\Delta(\textit{altitude drifted}) / \Delta(\textit{time in circling})$, where drifted means, it takes into account drift due to wind.

Thermal gain - shows the accumulated altitude from the start of circling. The GAIN NavBox shows the difference between current altitude and altitude recorded at the start of circling, which means this value can also be negative.

Flap position - current flap position. Requires the [LX Flap sensor for operation](#).

Rec. flap position - shows the recommended flap position, as defined by yourself in the [Glider](#) sub-section.

4.1.3.3 Status indicators

Flarm status

Is represented with a red Flarm symbol, depicted with [Flarm status indicator icon](#). If the Flarm icon is present, the device has an established connection with a Flarm device. On how to get more info from the Flarm device, check the [Info page](#) section. For information about Flarm objects and the Flarm radar page, check the [Flarm radar page](#).



Figure 4. Flarm status indicator icon

Connectivity status

The LX 10k has both Bluetooth and WiFi capability. Both modes are depicted with an appropriate icon.



Figure 5. Bluetooth status indicator



Figure 6. WiFi is on indicator



Figure 7. WiFi is connected indicator

The Bluetooth icon indicates the current wireless mode is set to Bluetooth. The WiFi icon shows in two colours. A black WiFi icon indicates the wireless mode as set to WiFi, while the green WiFi icon indicates that we have established a connection. For more information on connectivity, check the [Connectivity](#) section.

GPS status

The GPS status indicator indicates whether or not the device has a valid GPS lock. Under valid GPS lock, a connection to at least four satellites is required.



Figure 8. GPS signal is not valid



Figure 9. GPS signal is valid

Battery status

White battery outline indicates the device is running on external power, while a red battery outline indicates the device is running on internal power.



Figure 10. 1 red bar
(less than 10.8V)



Figure 11. 2 yellow bars
(more than 10.8V)



Figure 12. 3 green bars
(more than 12.0V)



Figure 13. 1 red bar
(less than 20 % backup
battery left)



Figure 14. 2 yellow bars
(21 - 80 % backup
battery left)



Figure 15. 3 green bars
(81 - 100 % backup
battery left)

Flight mode

The flight mode indicator depicts whether the device is currently in straight flight, or circling mode. The common way to transition between the two modes is by activating the SC (Speed Command) button/switch, or by using one of the automatic ways, implemented into the device.

For additional information on how to setup different input switches, check the **Inputs** section. For additional info on how to change between flight modes automatically, check the **Vario/SC** setup menu.



Figure 16. Device is currently
in circling mode



Figure 17. Device is currently
in straight flight mode

4.1.4 Turnpoint navigation page

This page is used for navigating towards a single turnpoint, from the .cup file, loaded into the LX 10k. The navigation screen shows turnpoints, airports, airspaces and ground elevation on the map.



Figure 18. Turnpoint page overview

Basic operation on this page has been explained in the **Navigation pages** section. Here, we will explain some specifics of the Turnpoint navigation page, and how to perform basic Turnpoint operations.

Pressing the **left push-rotary knob** will open the TP info sub-page, showing Bearing, Distance, Final glide and Elevation, if available.

Above the Bearing, an arrow is shown. The arrow can be either green or red, green indicating the turnpoint is within final glide and red indicating it is out of final glide. The direction of the arrow indicates the steering course, relative to your current track.

If the arrow is red in colour and pointing directly to the right, it means the turnpoint is out of final glide and you should turn 90° to the right in order to be on track to the turnpoint. The same logic is used in other navigation pages, as well as in the select airport and select turnpoint menu.

Pressing the **right push-rotary knob**, you will enter the 'Select turnpoint' sub-page. Here, a selection of turnpoints will be shown, along with distance and bearing, as well as **(relative bearing)** as described earlier, with an arrow. These points can be sorted by either Distance, Name, or Code.



Figure 19. Turnpoint additional info

Choosing Name or Code will open up the Filter setting, where you can type the name or code lettering. Choosing a turnpoint will set the turnpoint as the navigation point for the turnpoint navigation page.

For additional info on how to install database files, check the **Transfer** section of this manual.



Figure 20. Turnpoint selection sub-page



Figure 21. Search by name

4.1.4.1 Choosing a Turnpoint

To recap on how to choose a Turnpoint for navigation, follow these steps:

0. Have a .cup file loaded and selected
1. Go to the Turnpoint navigation page
2. Press the **right push-rotary knob**
3. Select the sorting criteria **Name, code and distance available**
4. Type in the Name or code if Name or code are chosen as sorting criteria
5. Scroll the list until you find the desired turnpoint. You can scroll regularly with the right push-rotary knob, or by 10-fold by rotating the left push-rotary knob
6. Confirm the desired point by pressing the right push-rotary
7. The device will automatically take you back to the Turnpoint navigation page and start navigating to the desired turnpoint.

NOTE

In order to use navigation pages to their full extent, be sure to have airspace (.cup), turnpoint (.cup) and airport (.af) files installed. Some of these, like .cup and .cup files, are available on competitions, from club managers, or governing national air bodies (like DAeC), while other, like the .af file, are provided solely by LX navigation.

NOTE

Files provided by LX navigation (.cup and .af) can be found on <http://www.lxnavigation.com/support/database/>. LX navigation does not provide official .cup files, for unofficial turnpoint files, you can check with your club mates and webpages like <https://www.openflightmaps.org/>.

NOTE

All final glide calculations take into account the current wind speed and direction, as well as reserve altitude and selected MC value. On the **Task navigation page**, the final glide calculation takes into account your kinetic energy as well, as explained in the said page.

4.1.5 Airport navigation page

The Airport navigation page is set up in much the same way as the Turnpoint navigation page, so be sure to check the previous section for additional information.

This page is used for navigating towards a single airport, from the .af file loaded into the LX 10k. The navigation screen shows turnpoints, airports, airspaces and ground elevation on the map area.



Figure 22. Airport navigation page overview

Basic operation on this page has been explained in the Navigation pages section. Here, we will explain some specifics of the Airport navigation page, and how to perform basic Airport operations.



Figure 23. Airport selection sub-page



Figure 24. Airport additional info sub-page

Pressing the **left push-rotary knob** will open the APT info sub-page, showing Bearing, Distance, Final glide, Elevation, Airport Frequency and Runway directions.

Pressing the **right push-rotary knob** you will enter the 'Select airport' sub-page. Here, a selection of airports will be shown, along with distance and bearing, as well as steering course (relative bearing) as described earlier, with an arrow. These points can be sorted by either Distance, Name, or ICAO code.

Choosing Name or ICAO will open up the Filter setting, where you can type the name or code lettering. Choosing an airport will set the airport as the navigation point for the airport navigation page.

NOTE

If you have a radio transceiver connected to the LX 10k, and the proper settings enabled, choosing an airport on the Airport navigation page will automatically set the frequency of the said airport as the reserve frequency on your transceiver. For additional info on how to enable this option, check the [Connecting a Radio](#) section of this manual.

NOTE

When selecting an airport, the lady from the LX 10k's internal voice module will notify you over the speaker of the runway's direction and airport frequency.

4.1.6 Task navigation page

This page is intended for task navigation. A task can be made using turnpoints, airports or a combination of both. It can be **uploaded a third party device via Bluetooth** as a declaration, **downloaded from the web, created on the device, or loaded from the .cup file**. On second seat devices, the task can be sent from the main (front seat) device.

In order to use this page to the fullest extent, be sure to have the latest .af and .cup files available. This navigation screen shows turnpoints, airports and airspaces on the map area, as well as the task, with task sectors and task lines, connecting the task sectors.



Figure 25. Task navigation page overview

Above the glider, on the map part of the screen, a box with either **'STAND BY'**, **'ARMED'**, **'FINISHED'** or no box can be shown. These show the current state of your task. **'STAND BY'** denotes that the task is in stand by mode, meaning that if you cross the start line, task navigation will not start. **'ARMED'** denotes that the task is armed, meaning task navigation will start, once the finish line is crossed. **'FINISHED'** indicates the task has been completed.

Pressing the **left push-rotary knob** will open the 'Task options' sub-page with the following settings:

- **Edit task** - Opens the 'Edit task' sub-page, explained in detail below
- **Delete task** - Deletes the task
- **Arm** - Will arm the task. If the task is not armed, crossing the start line will not start the task navigation
- **Reset** - Will reset the task to the state prior to crossing the start line
- **Next turnpoint** - Will change the navigation point to the next one in line
- **Previous turnpoint** - Will change the navigation to the previous one
- **Load task** - Will open the Load task setup menu

- **Export task** - Task will be exported to your external microSD card in a .cup file format, containing only the task, without any additional turnpoints, enabling easy sharing between devices.



Figure 26. Task options sub-page

Pressing the **right push-rotary knob** will open the 'Edit task' sub-page. This sub-page is used for selecting task points, setting the task time and turnpoint sectors. The selection of turnpoints and airports works in the same way as described in the previous two sub-sections.



Figure 27. Edit task sub-page 1



Figure 28. Edit task sub-page 2

In this sub-page, we can see the task time (if set, the task type will be set to AAT), calculated distance between sector centres and a list of turnpoints used in the following order:

- **Take-off (T)** - Does not have to be set, is not taken into account for navigation, can not be deleted

- **Start (S)** - The starting point of your task
- **n-number of intermediate points**
- **Finish (F)** - Finish line
- **Landing (L)** - Does not have to be set, is navigated to after the finish line has been passed, can not be deleted

By default, the task edit page shows only four points: Take-off, Start, Finish and Landing. Selecting the Take-off and Landing point, will offer the option of choosing a point from the turnpoint or airport list, in the same way as described in the [Turnpoint navigation page](#).



Figure 29. Navigation point action selection

Selecting the Start point will offer the option of choosing the navigation point, in the same manner as already noted for the Take-off and landing location before. Additionally, the options for Go to and Edit zone option are presented for the Start point.

If you wish to add additional navigation points, you need to select the Finish line point, where, in addition to the options offered for the star line, option for inserting a turnpoint or airport will be offered.

Choosing one of these options will insert an additional navigation point above the finish point. Similarly, when choosing one of the added navigation points, selecting the 'insert turnpoint' or airport will place the new navigation point above the chosen one.

Additionally, the finish line has the options of setting a finish altitude of 1000m below starting line, which, in case the finish point altitude is more than 1000m below the point of release from the tow plane, the device will navigate and calculate final glide to the altitude 1000m below the release from the tow plane. This condition is usually required for FAI record and badge flights.

NOTE

When choosing the 'Fin. 1000m below' option, keep in mind that the reserve altitude is also taken into account for final glide calculation, which means the final glide will be calculated higher than needed, as an additional layer of reserve.

The finish point has an additional option of setting the 'Finish altitude'. When set, this altitude will be used for calculating the final glide altitude (effectively raising or lowering the point).

NOTE

When setting the 'Finish altitude', keep in mind the reserve altitude is added to this value, when calculating final glide, meaning, if the reserve altitude is set to 200m and the Finish altitude is set to 50m above the turnpoint (294m for a 244m high point), the final glide will be calculated for the altitude of 250m above the said point.

NOTE

It is important to note that the LX 10k is calculating **DYNAMIC FINAL GLIDE**, when flying towards the Finish Line of a task. Dynamic final glide means, that the LX 10k expects you to fly through the finish line with a speed of 27 m/s (97.2 km/h). When flying faster than 97.2 km/h in your final glide, the LX 10k will expect you to perform a pull-up and slow down immediately before the finish line, thus converting part of your kinetic energy into potential, or part of your speed into altitude. If you do not pull up, you will go **below the calculated final glide**. This feature optimizes your Final Glide calculation, as it uses your energy as well, rather than just your Final Glide information, thus giving you greater speed. Please note, that performing strong pull-ups near the Finish line is prohibited on some competitions and might be considered dangerous, so perform the pull-ups slowly, allowing aircraft behind you to react.

Opening 'Edit zone' will open the standard list of zone, or sector, settings:

- **Turnpoint name**
- **Type**
 - **Symmetric**
 - **Fixed**
 - **To next**
 - **To previous**
 - **To start**
- **A21**
- **A1**
- **R1**
- **A2**
- **R2**
- **Line option** - ticking this option will set the current sector type to line
- **View** - **shows** the sector, useful for checking with the sector shape shown on the task sheet
- **Next zone** - will change the current zone being edited to the next one in line
- **Previous zone** - will change the current zone being edited to the next one in line



Figure 30. View zone option



Figure 31. View zone page

NOTE

Choosing the 'Go to' option in the Edit task sub-page on a navigation page will set the selected point as the current navigation point on your Task navigation page.

NOTE

The quickest way to set up the task on the LX 10k is to first set the list of navigation points, and after this set the sectors for all of the points.

NOTE

Default sectors for start, intermediate and finish points can be set in the **Task** setup page. These sectors will be used whenever a new task is created on the LX 10k as standard.

NOTE

The task must be armed, in order for task navigation to start, once the start line has been crossed. If you forget to arm the task, and remember once already on your task, choosing the 'Next turnpoint' option will start the task navigation. Choosing the 'Next turnpoint' multiple times will move through the task points. If the desired turnpoint is overshoot, you can choose the 'Previous turnpoint' in order to revert. If you have started the task prematurely, you can choose the reset option to go to the state prior to starting the task.

4.1.7 Nearest landable navigation page

The Nearest landable navigation page (NRST) is the simplest of the four navigation pages. This page always navigates to the nearest landable point. This landable point can be either an airport from the .af file or a turnpoint, marked as a landable, from the active .cup file.



Figure 32. Nearest landable page overview

This page has no settings nor editable data. It's sole purpose is to provide the pilot with immediate, clear information on the nearest landable point.

For additional info on the point being shown, press the **left push-rotary knob**, and the page noted by Fig. [24](#) will be shown.

NOTE

For proper functioning of the Nearest landable navigation page, it is paramount you have both the .af and .cup file loaded to the device and set as active.

4.1.8 GPS DATA INVALID

If you lack a GPS connection, there will be a red cross across the screen and 'GPS DATA INVALID' written in a notification box.

If this happens, check that your device has a clear line of sight from the GPS antenna to the sky, and wait for the device to connect.



Figure 33. GPS DATA INVALID

NOTE

In order to use navigation pages to their full extent, be sure to have airspace (.cub), turnpoint (.cup) and airport (.af) files installed. Some of these, like .cup and .cub files, are available on competitions, from club managers, or governing national air bodies (like DAeC), while other, like the .af file, are provided solely by LX navigation.

NOTE

Files provided by LX navigation (.cub and .af) can be found on <http://www.lxnavigation.com/support/database/>. LX navigation does not provide official .cup files, for unofficial turnpoint files, you can check with your club mates and webpages like <https://www.openflightmaps.org/>.

NOTE

All final glide calculations take into account the current wind speed and direction, as well as reserve altitude and selected MC value. On the **Task navigation page**, the final glide calculation takes into account your kinetic energy as well, as explained in the said page.

4.2 Thermal assistant page

The Thermal assistant page is a pilot's best friend while thermalling. It is designed to provide the pilot with all relevant information while in a thermal.

The TA page incorporates four NavBoxes, showing the following parameters:

- **T AVG** - shows the average vertical speed for the whole thermal, since the device detected the start of circling, up to the current point in time
- **AVG** - shows the integrated vertical speed for the time duration set in the **Vario/SC** setup menu
- **MAX** - the maximum variometer value in the last circle (360 degree turn). This is the same value as is represented by white dot on TA page.
- **GAIN** - shows the accumulated altitude from the start of circling. The GAIN NavBox shows the difference between current altitude and altitude recorded at the start of circling, which means this value can also be negative.



Figure 34. Thermal assistant page overview

On the left side, the IAS sliding speed tape is present, with the appropriate colour arcs, as well as the TAS, displayed below the speed tape.

On the right side, the altitude sliding tape is present, as well as set QNH in a box below the speed tape.

In the middle of the screen, we can see the actual **Thermal assistant**, embodying the **Wind indicator**. The Wind indicator works much the same as already noted in **Wind indicator**.

The **Thermal assistant** is an indicator, whose main function is to map the strength of the thermal in the last full circle and give the pilot an idea of his actual position in the thermal, thus

helping him center.

A glider represents the pilot's current position in the thermal. The glider can be either on the left side (circling to the right), or the right side (circling to the left) of the Wind indicator.

Next we see dots forming a circle, at 18 degree intervals. These dots represent discretized parts of the thermal. The dots are either red or blue. Red indicates a lifting part of the thermal and blue a sinking part. The size of the dot indicates the intensity, larger dots representing greater vertical speeds, in either direction. A single dot (white when dark theme is used and white with black outline when light theme is used) represents the strongest part of the thermal during your last circle.



Figure 35. TA options overview

Pressing the **right push-rotary knob** will open the TA options page. Here, we can choose to turn on different functions, such as:

- **Auto TA** - Ticking this option will make the LX 10k turn to TA page when it detects circling has started. Once the LX 10k detects it is no longer circling, it will revert back to the page you had before.
- **MC color** - When MC color scheme is ticked, red dots represent climb which is stronger than $1.2 \cdot MC$ value set. Yellow dots represent climb in range of $0.8 \cdot MC$ and $1.2 \cdot MC$ value set. Blue dots represent climb less than $0.8 \cdot MC$ value. If MC setting is less than 0.5m/s , default color scheme is used.
- **Max beep** - The device beeps when you are passing through the point at which the maximum thermal strength was recorded in your last turn.
- **Beep offset** - Offsets the beep by a set amount of seconds.

4.3 Flarm radar page

The Flarm radar page shows all surrounding objects reported to the LX 10k by a Flarm device. If the said Flarm device has an ADS-B module, the LX 10k will show ADS-B objects as well. Flarm objects are shown on a radar screen with track-up orientation.



Figure 36. Flarm radar screen



Figure 37. Flarm radar select circle

Gliders presented as a dot on the screen, are gliders where pilots have intentionally activated the PRIVACY mode on their Flarm unit. Gliders in privacy mode send limited data strings and can't be visualized completely. However, all warnings will appear regardless of privacy mode.

Pressing the **right push-rotary knob** will invoke the selection of a Flarm object to follow. For a selected object, relative altitude and vertical speed of object will be displayed on the screen, as depicted on Flarm radar select circle.

Rotating the **left push-rotary knob** will change the zoom of the flight radar screen and pressing it will open the Flarm objects sub-page. In the Flarm sub-page, a list of all visible aircraft is shown. A green dot next to the name of the object shows which object has been select for additional info on the Flarm radar page. Object ID and distance is also shown.

By choosing an object and pressing the right push-rotary knob, additional information can be seen and/or edited, for each object:

- **Callsign**
- **Pilot**
- **Airfield**
- **Registration number**
- **Frequency**
- **Flarm ID (always non-changeable)**

The LX 10k supports FlarmNET database files, check [Flarm NET](#) section for additional information.



Figure 38. List of visible Flarm objects



Figure 39. Additional options for objects

An important safety feature of the LX 10k is the Flarm warning page. This page pops-up whenever the Flarm device sends a warning sentence, regardless of the menu, page or setup you're currently in.



Figure 40. Flarm warning page

The Flarm warning screen shows the type of object the Flarm is warning you about, from the list of supported Flarm objects (Skydiver shown on figure). It's relative direction to your heading, relative altitude and distance, as well as an angle from the horizon, with the blue/brown scale on the left side of the screen. The relative direction of the object is also written in word with **SKYDIVER 12 O'CLOCK ABOVE**.

The LX 10k can show the following objects with appropriate graphics:

- **Unknown** - 
- **Drop plane** - 
- **UFO** - 
- **Glider** - 
- **Hang-glider** - 
- **Balloon** - 
- **Tow plane** - 
- **Para-glider** - 
- **Blimp, zeppelin** - 
- **Helicopter** - 
- **Powered aircraft** - 
- **UAV** - 
- **Skydiver** - 
- **Jet aircraft** - 
- **Obstacle** - 

NOTE

A lot of effort was put into the design of the Flarm Warning screen, shown by figure 34. It's sole purpose is to quickly familiarize the pilot with the potential danger. Flarm provides us with three distinctive levels of danger:

- **13 to 18 seconds to impact** - the Flarm Warning screen appears, the LX 10k's internal beeper and the flashing of the direction cone are in the same, steady frequency. The lady from the LX 10k's internal voice module notifies you of the location of the object.
- **9 to 12 seconds to impact** - same as previous level, both the internal beeper frequency and beeping interval, as well as the flashing interval, intensify (higher frequency)
- **0 to 8 seconds to impact** - as on previous level, with the highest frequency of beeping and flashing.

4.4 AHRS page

The AHRS page utilizes the LX AHRS module in order to provide the pilot with important flight parameters. The **LX AHRS module** is required for the use of AHRS page.



Figure 41. Attitude indicator on PFD page

The AHRS page offers the pilot the following flight parameters:

- **Attitude**
- **Pitch set**
- **Bank angle**
- **IAS tape with TAS** - as described in the [Thermal assistant page](#)
- **Altitude tape with QNH** - as described in the [Thermal assistant page](#)

Attitude and horizon line are displayed as blue sky and brown ground. The border between the two is separated with a white line representing the horizon.

The attitude indicator displays the pitch (indicated by the yellow symbolic aircraft on the pitch scale), bank, and slip/skid information.

The horizon line is part of the **pitch** scale.

Pilot can see following pitch scale markings:

- **0° – pitch markings** Known also as "Horizon line"
- **2.5° – pitch markings** Found at the interval between 0° and +20° –
- **5° – pitch markings** Found at the interval of +50°
- **10° – pitch markings** Found at the interval between +50° and +90°

Bank scale - the inverted white triangle indicates zero on the bank scale. Major tick marks at 30° and 60° and minor tick marks 10°, 20°, and 45° are shown to the left and right of the zero. Angle of bank is indicated by the position of the pointer on the bank scale.

Turn coordinator



Figure 42. Turn coordinator indicator

Standard rate turn indicator - standard rate turn indicator is represented by two airplane silhouettes on the bank indicator. The silhouettes are hidden when IAS is less than 10 m/s.

The pilot performs standard rate turn when the bank indicator marker (yellow triangle) aligns with airplane silhouette.

The standard rate turn is defined as 3° per second turn (which gives a complete 360° turn in 2 minutes).

Bank pointer - bank pointer is displayed as a yellow triangle and is always fixed at its position. Underneath the yellow triangle we can find Slip/skid indicator.

Slip/skid indicator is displayed as a thin rectangle below the Bank pointer. The combination of the two is also referred to as "sailboat" due to its looks.

4.5 G-force page

This page utilizes the LX 10k's internal inertial platform for showing the current, maximum and minimal G-loading during a flight, both numerically and graphically. The page also shows the IAS sliding tape, TAS, altitude sliding tape and QNH, as depicted on the [Thermal assistant page](#). Your current G-load is shown graphically with a red dot.



Figure 43. G-force page overview

Pressing the **right push-rotary knob** will open the 'G-force options' sub-page, where you can reset the Min. and Max. values to zero.

Rotating the **left push-rotary knob** will change the scale of the G-force circles.

NOTE

1 G corresponds to the average acceleration of the Earth's gravity field on it's surface, or $9,81m/s^2$.

NOTE

It is important to note, that the LX 10k shows accelerations in the Y-Z plane, as depicted by Fig. 44., meaning no longitudinal accelerations are shown. If the plane is experiencing an acceleration of 1 G in the X axis the LX 10k will show 0 G.

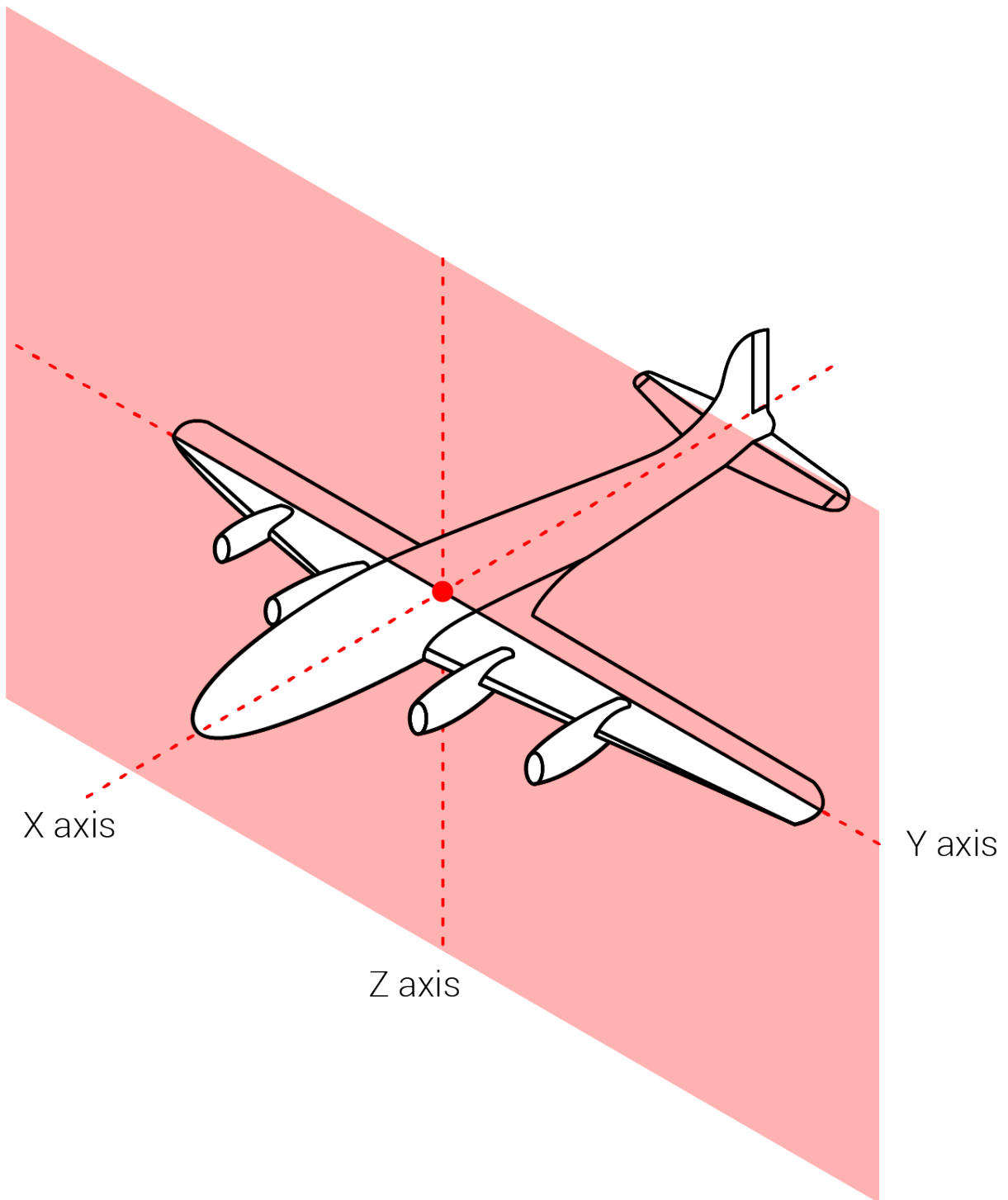

Figure 44. Airplane axis and the Y-Z plane

4.6 Info page

The info page shows the current GPS status and additional info, received from the GPS, like the GPS location, UTC time and date.

The device shows the battery voltage of both the LX 10k's internal battery and the external (airplane) battery.

Lastly, the page shows the Flarm connection status, and Flarm device ID, if a Flarm device is connected.



Figure 45. Info page overview

NOTE

The event function can be triggered by pressing the **right push-rotary knob**, while on this page. The activation of the Event function will be accompanied by a notification box, as depicted by Fig. 73.

4.7 Logbook/Flight statistics page

This page can be either the 'Logbook' or 'Flight statistics page, based solely on if the device is in flight mode. Additional info on flight mode can be found in sub-section **A word on internal battery and flight mode.**

4.7.1 Logbook

When the device is not in flight mode, this page will be in Logbook mode.



Figure 46. Logbook page

Entering the Logbook page will show the list of all flights the LX 10k has in its memory. Rotating the right push-rotary knob will move down the list. Pressing the right push-rotary knob will open additional info on flights, as well as the options for transferring flights to a microSD card or for sending a flight to an email address. For additional info on how to setup everything you need for sending flights to an email address, check the **WiFi connectivity** section.

You can use the left push-rotary knob for jumping through the list of flights by the order of 10. If you press in the push-rotary, while rotating it, it will jump through flights by the order of 100.

NOTE

Even though the LX 10k has a large amount of internal memory (8 GB on earlier models and 16 GB on new models), it is considered good practice to regularly download those flight and keep them on a separate drive, as a backup.



Figure 47. List of flights in the logbook



Figure 48. Flight details in the logbook

4.7.2 Flight statistics

Once the device enters flight mode, which is explained in detail in sub-section **A word on internal battery and flight mode**, the Flight statistics page appears.



Figure 49. Flight statistics page

We can see the take-off time, flight duration, maximum altitude and maximum indicated airspeed, as well as an altitude graph.

NOTE

Once the LX 10k determines that you are not in flight, it will start the 5 minute countdown to finishing your flight. Once the countdown has finished, it will calculate the security and save the .igc file to its internal memory.

The conditions for finishing a flight are:

- GPS lock
- Ground speed less than 10 m/s
- Indiacted airspeed less than 10 m/s
- Altitude less than 3000 m QNH

NOTE

If you wish to forcefully finish a flight, prior to the LX 10k starting the finish procedure, you can do this by going to the 'Flight statistics' page and pressing the right push-rotary knob and confirming the 'End flight?' question, as shown in figure 54.



Figure 50. 'End flight?' dialog box

WARNING

If the LX 10k turns off due to both the internal and external power supply being drained, the IGC flight might not get the IGC seal.

4.8 Airspace page

The 'Airspace' page is intended for informing the pilot of the airspace surrounding him.

The LX 10k looks up all airspace in the vicinity of the pilot's current location and lists them in regards to distance. The list shows airspace name, type and horizontal distance.



Figure 51. Airspace page

Selecting an airspace, a new screen with the airspace shown graphically, with your relative location shown, as well as type, vertical and horizontal distance and whether you're inside or out.



Figure 52. List of airspaces

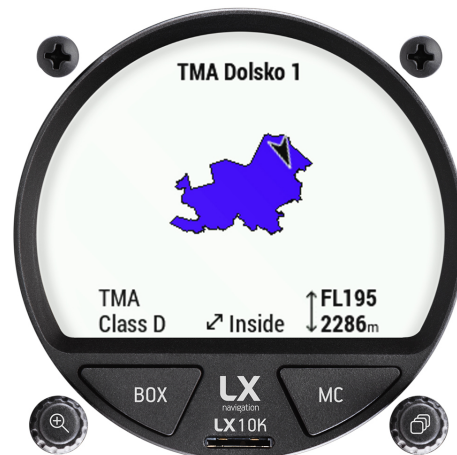

Figure 53. Airspace details

4.9 Setup page

The Setup page, or Setup menu will be processed in the **Device setup** section.



Figure 54. Setup page

Device setup

This section will go through the complete setup process for the LX 10k variometer. It is important to note that the Setup menu is divided into two sections - the **User** and **System** settings.

All of the settings in the User sub-part of the Setup menu are saved to a specific Pilot profile and change, when a pilot profile is changed. These settings should be tailored by each pilot to his own preferences.

The System part of settings embodies all of the glider and system related settings, which do not change with changing of the pilot, i.e. glider type, localisation, etc.

NOTE

User settings should be set only once for each pilot profile, while the System part of settings should be set only once.

5.1 User settings

The user part of setup incorporates the following sub-menus:

- **Pilot**
- **Vario/SC**
- **Task**
- **Indicators**
- **Voice**
- **Pages**
- **Graphics**
- **Warnings**
- **Logger**

5.1.1 Pilot

The Pilot setup sub-menu holds the following settings:

- **Active pilot**
- **Name**
- **Surname**
- **Mass**
- **Reserve**
- **Copilot name**
- **Copilot surname**
- **Copilot mass**
- **Club profile**
- **Import file**
- **Export file**
- **Delete pilot**

The Pilot sub-menu holds all of the pilot and copilot related information. Each pilot profile is at the same time the user profile to which all user settings are saved to, as discussed in the introductory part of the **Device setup sub-section**.

In order to create a new pilot profile, select the 'Active pilot' field and choose 'EMPTY'. Now, set the name, surname, mass and reserve values for your profile. As soon as you type in your name, your new pilot profile will be saved to the pilot list. You can choose the 'EMPTY' slot again to create yet a new pilot profile.

One can select a pilot profile either in the initial setup, as noted **Turning the LX 10k on** sub-section, or by choosing it in this sub-menu. Once a pilot profile has been selected, all changes made will be saved to the selected pilot profile, unless **Club mode** is engaged, and this pilot's profile settings will be used for the current flight.

NOTE

Pilot and Copilot name and surname are written into the declaration of the IGC flight, so be sure to have the correct information if badge, record or competition flights are planned.

NOTE

The pilot and copilot masses are used for calculating wing-loading and the adjustments made to the aircraft polar, used for calculation of final glide, so great care should be taken to insert the correct information.

This page also houses the 'Club profile' checkbox (additional info in **Club mode** sub-section), as well as the options for Importing, Exporting and deleting a pilot profile. Exporting and Importing a pilot profile will save not only the information in this sub-menu, but all settings in the User part of the Setup menu.

NOTE

The reserve altitude is used for FG (Final Glide) calculation. If the device calculates an arrival altitude of 350m, and the reserve altitude is set to 200m, the FG, which will be displayed on all navigation pages and in the FG NavBox will be 150m.

WARNING

Due to the direct impact of Reserve altitude on the final glide calculation, always make sure prior to take-off that the Reserve altitude is set to a value you are comfortable with. Pilot, copilot and ballast mass also influence the FG calculation, but to a comparatively lesser degree to the Reserve altitude setting.

5.1.2 Vario/SC

The Vario/SC setup sub-menu is used for setting all vario-related parameters and holds the following settings:

- **Altitude Sensor** - lets you choose which sensor will be used for determining your current altitude. The LX 10k has two static pressure sensor, an internal - the IGC pressure sensor, and an 'external' - the one connected to the TE/ST pressure port on the back of the device.
- **Zero frequency** - the frequency of the tone generated by the LX 10k, when the vario is showing 0 m/s.
- **Positive frequency** - the frequency of the tone generated by the LX 10k, when the vario is showing 5.0 m/s.
- **Negative frequency** - the frequency of the tone generated by the LX 10k, when the vario is showing -5.0 m/s.
- **Audio test** - this option will run the tone output from positive to negative frequency, which will allow you to hear your current frequency range and adjust if necessary.
- **Range** - lets you choose between 2.5, 5.0 and 10.0 m/s range on the vario scale (and appropriate value when other units are in use).
- **Filter** - sets the response of the variometer to changes in pressure. The smaller the value, the more responsive the vario is, but at a cost of showing all of the small vertical movement, whereas the higher levels are more slow to react, but level off minute vertical movements.
- **TE Level** - electronic TE (Total Energy) compensation. The LX 10k is capable of electronic compensation of total energy, meaning the TE probe is not required for the instrument to be compensated.
- **Integration time** - used when calculating the average thermal strength for the past set amount of seconds.
- **Vario silence** - the value below which the vario will not produce any sound. Usually used for small negative or positive values, if not wanting to be distracted by small differences from the zero.
- **Max circling speed** - a set speed above which the variometer will be silent, if in SC mode.
- **SC mode** - sets how the device switches between Vario and SC modes:
 - **Manual** - the pilot switches between the two modes manually, by pressing the SC button on the stick.
 - **Circling** - the device switches automatically, when it detects circling, as depicted in the **Flight mode** sub-section.
 - **Speed** - the device switches automatically, when a set speed is surpassed.
- **SC silence** - is an interval between 0 and a set value, inside of which the Vario will not produce any vario sounds, if in SC mode.

NOTE

For the device to detect circling, you must have a constant change of 5° per second in your heading for at least 8 straight seconds. Turns usually last about 30 seconds, meaning your turn rate is around 12° per second, this means that circling will be detected after approx. a third of a circle has been made.

5.1.3 Task

The Task setup sub-menu is used for setting up the default sectors for turnpoints to be used, when a new task is created. The sub-menu holds the following settings:

- **Default start** - sets the default starting sector parameters
- **Default point** - sets the default turnpoint sector parameters
- **Default finish** - sets the default finish sector parameters

5.1.4 Indicators

The Indicators setup sub-menu holds the setup parameters for indicators on **Vario Indicator Unit**. Two different sets of indicators can be set for each flight mode.

The two flight modes - circling and straight flight are denoted as Vario (circling) and SC (straight flight, 'Speed Command'). Different indicators can be assigned both to the needle as well as to numerical indicators. Pressing the SC switch will change between the two sets of indicators.

Depending on the type of the **Vario Indicator Unit**, you can have either the option of 4 NavBoxes (for the digital unit) or 2 NavBoxes (for the analog unit). Furthermore, the Digital unit can be set to showing 2 larger NavBoxes instead of 4 smaller ones, if the '4 NavBox items' is checked. The following settings are available here:

- | | |
|-------------------------|----------------------|
| • Vario needle | • SC needle |
| • 4 NavBox items | • SC NavBox 1 |
| • Vario NavBox 1 | • SC NavBox 2 |
| • Vario NavBox 2 | • SC NavBox 3 |
| • Vario NavBox 3 | • SC NavBox 4 |
| • Vario NavBox 4 | |

If the system has the digital vario indicator unit, the pilot can also choose between two and four numerical indicators on the main page, offering a choice between more info and better legibility.

The following digital needle indicators are available:

- **Vario** - shows the current compensated vertical speed (vario value)
- **SC** - shows the current SC (Speed Command) value - same as the green arc, as described in the **Vario Indicator Unit** sub-section
- **Netto** - described below
- **Relative** - described below
- **G-force** - the current G-force, as described in the **G-force page** sub-section



Figure 55. Four indicators on a white background theme



Figure 56. Two indicators on a black background theme

The following digital numerical indicators are available:

- Empty
- UTC time
- Local time
- Flight time
- Altitude
- IGC altitude
- Flight level
- Density altitude
- Alt. QNH [ft]
- Vario
- Vario AVG
- Vario netto
- Vario relative
- TAS
- IAS
- Ground speed
- True track
- Distance Tp
- Distance Apt
- Distance Tsk
- Distance Nrst
- Final glide Tp
- Final glide Apt
- Final glide Tsk
- Final glide Nrst
- Bearing Tp
- Bearing Apt
- Bearing Tsk
- Bearing Nrst
- Speed to fly
- Task time elapsed
- Task time left
- Current efficiency
- Req. efficiency Tp
- Req. efficiency Apt
- Req. efficiency Tsk
- Req. efficiency Nrst
- Thermal max
- Thermal average
- Eff. thermal avg.
- Thermal gain
- Circling radius
- OAT
- ENL
- G-force
- Flap position
- Rec. flap position

Since most of the indicators are self-explanatory, we will cover the ones that are not.

IGC altitude - altitude displayed by the internal IGC pressure sensor, which is not offset by QNH changes.

Density altitude - the density altitude is the altitude relative to standard atmospheric conditions at which the air density would be equal to the indicated air density at the place of observation.

Vario AVG - average vario calculated by integration according to given settings (the same navbox is shown also on [Thermal assistant page](#) - AVG).

Vario netto - the actual vertical speed of the surrounding air mass. Is calculated by adding the current vertical speed indicated by the variometer, and the sink rate of the glider at that speed. Sink rate of the glider is calculated from the polar.

Vario relative - is Vario netto - 0.7 (sub-tracted for 0.7).

True track - true track based on GPS data.

Task time elapsed - shows elapsed time from starting a task.

Task time left - shows time left on task. Applicable only on AAT tasks.

Current efficiency - your current glide ratio, calculated by dividing your ground speed by your vertical speed.

Req. efficiency - required glide ratio for arriving on set navigation point (includes reserve altitude).

Thermal max - the maximum variometer value in the last circle (360 degree turn). This is the same value as is represented by white dot on TA page.

Thermal average - average vario calculated as: delta altitude / delta time in circling (same navbox on TA page - T AVG).

Eff thermal avg. - delta altitude drifted / delta time in circling, where drifted means, it takes into account drift due to wind.

Thermal gain - shows the accumulated altitude from the start of circling. The GAIN NavBox shows the difference between current altitude and altitude recorded at the start of circling, which means this value can also be negative.

Flap position - current flap position. Requires the LX Flap sensor for operation.

Rec. flap position - shows the recommended flap position, as defined by yourself in the Glider sub-section.

5.1.5 Voice

The Voice setup sub-menu holds the volume and mixer options for voice warnings, as well as a list of available voice warnings to choose from.

- **Volume**
- **Mixer**
- **Flarm traffic**
- **Flarm warning**
- **Flarm obstacle**
- **Flarm h. distance**
- **Flarm v. position**
- **Thermal vario avg.**

5.1.6 Pages

The pages setup sub-menu provides the pilot with a list of all primary pages. The pilot can choose to show or hide different pages, i.e. hiding the AHRS page if you lack the AHRS module.

- **Thermal assistant**
- **Flarm**
- **TP page**
- **APT page**
- **TSK page**
- **NRST page**
- **G-force**
- **AHRS**
- **GPS info**

5.1.7 Graphics

The Graphics sub-menu provides the pilot with options for personalizing the graphical appearance of the LX 10k.

The following sub-pages exist:

1. **Airspace**
2. **Map**
3. **Task**
4. **NavBox settings**
5. **Theme**

5.1.7.1 Airspace

The airspace sub-menu holds the settings for colour and transparency of the fill and outline for the following airspace types:

- **Controlled zone**
- **Prohibited**
- **Restricted**
- **Danger**
- **Terminal area**
- **Airway**
- **Glider**
- **Military**
- **Other**
- **Class A, B**
- **Class C**
- **Class D**
- **Class E**
- **Class F**

5.1.7.2 Map

The Map sub-menu holds settings for the graphical appearance of the Map are on all navigation pages. The following settings are available.

- **Orientation** - offers the two common map orientations - 'North up' and 'Track up'.
- **Color palette** - offers the pilots different color palettes to choose from for the map altitude defined coloring. Different color palettes are shown below.
- **TP/APT text size** - changes the size of airports and turnpoints names on the map.
- **TP/APT text color** - changes the color of airports and turnpoints on the map.
- **Dest. line colour** - the colour of the line connecting your current position and your navigation point.
- **Track line colour** - the colour of the line showing your current true track.
- **Display Terrain** - whether or not to show the color-coded terrain elevation.
- **Display tail** - whether or not to show the tail of the aircraft (tail representing your past track).
- **Display APT names** - whether or not to display airport names (alongside the icon) on the map.
- **Display TP names** - whether or not to display turnpoint names (alongside the icon) on the map.

The LX 10k incorporates terrain elevation information for the whole world (as much as provided by NASA satellites, limited availability in the far North and South). Based on this info, the terrain elevation is shown with the following color palettes:



Figure 57. Color Palette - LX Navigation 1



Figure 58. Color Palette - LX Navigation 2



Figure 59. Color Palette - Imhof 1



Figure 60. Color Palette - Imhof 2



Figure 61. Color Palette - Imhof 3



Figure 62. Color Palette - LX Navigation 3



Figure 63. Color Palette - LX Navigation 4



Figure 64. Color Palette - ICAO



Figure 65. Color Palette - Orange



Figure 66. Color Palette - UK



Figure 67. Color Palette - Black and white



Figure 68. Color Palette - Black (no elevation)



Figure 69. Color Palette
- White (no elevation)

NOTE

APT icons are shown on the map up to a zoom level of 25km. TP icons are shown up to a zoom level of 9km. At higher zoom levels we are only showing Airspace lines, due to the legibility.

5.1.7.3 Task

The Task sub-menu holds settings for the graphical appearance of task features on the task navigation page map. The following settings are available.

- **Active zones** - outline, fill and start/finish line.
- **Inactive zones** - outline, fill and start/finish line.
- **Task legs**
 - **Legs yet to cover**
 - **Active leg**
 - **Course to TP**
 - **Covered leg**

5.1.7.4 NavBox settings

Takes you to the selected navigation pages and starts the NavBox selection function for the said page, in the same manner as explained in [The NavBox line](#) sub-page setup.

5.1.7.5 Theme

The Theme sub-menu offer the pilot to choose between 4 themes. The LX 10k features has two areas for themes - the vario scale and the internal part (everything inside of the vario scale). For each of these two a white or black option is available, giving us four combinations.

The first colour indicates the colour of the central part of the display, and the second colour indicates the digital needle part of the display:

- **Black panel**
- **White panel**



Figure 70. White panel



Figure 71. Black panel

WARNING

Changing the theme will cause the unit to instantly restart. Changing the theme in flight is not possible, due to this reason.

NOTE

Experience has shown that in high sunlight conditions, the 'White panel' colour theme is most visible, while the 'Black panel' colour theme is least straining for the eyes in low light conditions. Of course, sometimes it is just a matter of taste, which means De gustibus non est disputandum.

5.1.8 Warnings

The Warnings setup sub-menu gives the pilot an overview of which warnings are available. In the case of this sub-menu, warnings refer to a warning, that is given by the LX 10k to the pilot in the shape of a red square as shown with the picture below:



Figure 72. A warning screen

The following warnings are available:

- **Audio** - whether or not to play audio warnings in general
- **Inputs** - inputs warnings include all warnings that depend on an external input, as depicted in the **Inputs** section of this manual
- **Flarm** - display warnings sent by Flarm devices
- **Airspace** - display warnings concerning airspace infringements
- **Stall** - display stall speed warning
- **Vne** - display V_{NE} speed warning
- **AS vertical limit** - set vertical distance from airspace when the warning is shown
- **AS horizontal limit** - set horizontal distance from airspace when the warning is shown
- **AS button value** - set time value, how long an airspace warning for a particular airspace will be muted for
- **Max. altitude** - set a maximum altitude warning

5.1.9 Logger

The Logger setup sub-menu holds all IGC logging - relevant settings. The Event function is an IGC mandatory function which, for a set period of time, changes the logging interval from the regular 'Interval' value, to the 'Event interval' value, which is usually more frequent and writes a special line in the **.igc** file.

In the past, the event function was used because less internal memory was available for flight logging and consequently less frequent logging intervals were set as standard (5s). When the event button was triggered, the logging changed to the 'Event interval', thus ensuring your ticking of the sector was captured with a high enough resolution.

In present times, event buttons are frequently used in new types of competitions starts, where the pilot marks his intention on actually crossing the line.

The moment at which the Event button is pressed is captured in the .igc flight with an event sentence, which is why it is useful for all kinds of tests, when we wish to mark a certain point in time.

The following options are available in the Logger sub-menu setup:

- **Interval**
- **Event interval**
- **Event fixes**
- **Start speed**

The **Start speed** sets the IAS at which logging will begin, as depicted in **Flight mode** section.



Figure 73. Event info box

NOTE

The event function can be triggered in two ways. Firstly, by having a dedicated external button connected to the **Inputs** interface and pressing it, or secondly, by going to the **Info page** and pressing the right push-rotary knob. Either way, the activation of the Event function will be accompanied by a notification box, as depicted by Fig. 73.

5.2 System settings

5.2.1 Glider









The following glider associated settings can be found in this sub-menu:

- **Polar** - sets the polar by which final glide is calculated. The LX 10k has a large and ever-growing selection of glider polars. In case your glider polar is not listed, you can create a user specified polar.
- **Arispeed** - will open the airspeed sub-menu, where the specific airspeeds can be set. These airspeeds will be used for warnings, as well as for colouring the speed arcs on specific primary pages.
 - **VS1** - represents the stall speed of the aircraft (beginning of green arc)
 - **VNO** - represents the maximum normal operating speed (end of green and beginning of yellow arc)
 - **VNE** - represents the never exceeded speed (red arc)
- **Registration nr** - the registration of the glider, is saved to the IGC declaration
- **Competition ID** - competition ID of the glider, is saved to the IGC declaration
- **Class** - competition class of the glider, is saved to the IGC declaration
- **Ballast dump rate** - sets the average dump rate when the ballast dump valve is opened. This is especially useful for glider which can close the valve again, as the amount of ballast will have changed. The ballast dump rate require a switch to be connected to the inputs interface and set up properly. When activated, it will start changing the amount of set ballast by the rate set in this setting. It should be noted, that the ballast dump rate is not constant in real-life circumstances, as it depends on a multitude of factors. We approximate a fix ballast dump rate.
- **SC switch** - sets the type of switch used for the Speed Command button. On or Off should be used for a lever switch and toggle for a push-button.
- **Category** - which category of aircraft does your aircraft belong to. Changing this will change the aircraft icon, as depicted with the aircraft icons selection below.
- **Flap positions** - Opens the flap positions setup menu. Adding a new flap position will record the current flap position (requires the **Flap sensor**), for which a pilot can assign the Name, Min. speed and Max. speed. Once set, these Flap positions will be used for current and recommended flap position indicators. If the Flap sensor is not connected, the pilot can still set the Flap airspeeds and positions and use the Flap rec. position NavBox. If the Flap sensor is connected, another info box appears in the setup page, with the percentage of Flap sensor extensions shown.

NOTE

All glider polars are represented by a quadratic approximation.

Aircraft icon selection:

- **Airplane** - 
- **Rotorcraft** - 
- **Jet** - 
- **Glider** - 
- **Gyrocopter** - 
- **Fighter** - 
- **Motor glider** - 
- **Airship** - 

NOTE

To create a User specified polar, go to Setup > Glider > Polar > Select polar and choose the User polar. Once chosen, you can change the A, B and C parameters, as well as Empty mass, Reference mass, Maximal mass and Wing area. The A, B and C polar parameters are the coefficients located next to the square, linear and constant part of the quadratic function, as depicted in the following formula:
 $A * x^2 + B * x + C$. The reference mass is the mass, for which the polar has been calculated.

5.2.2 Units

Sets the units used for different parameters throughout the device. The following parameters and units are available:

- **Altitude** - meters [m] or feet [ft]
- **Climb rate** - meters per second [m/s], knots [kts] or feet per minute [fpm]
- **Speed** - kilometers per hour [km/h], miles per hour [mph] or knots [kts]
- **Wind speed** - kilometers per hour [km/h], miles per hour [mph], knots [kts] or meters per second [m/s]
- **Distance** - kilometers [km], nautical miles [nm] or statute miles [mi]
- **Pressure** - hectopascal [hPa], inches of mercury [inHg] or millibars [mb]
- **Temperature** - degrees Celsius [C] or degrees Fahrenheit [F]
- **Weight** - kilograms [kg] or pounds [lb]
- **Aera** - square meters [m²] or square feet [ft²]

5.2.3 NMEA

The NMEA sub-menu is used for determining which sentences are being sent out through the User port, Flarm port and the Bluetooth connection. This sub-menu will only explain in small detail what is available and what it is used for. For more information on connectivity, check the **Connectivity** section.

The following settings are available:

- **Flarm** - sets the baudrate for the Flarm port. Default value is 19200.
- **User** - sets the baudrate for the User port. Default value is 38400.
- **GPGGA** - forwards GPGGA (Fix information) sentences received from GNSS module.
- **GPRMC** - forwards GPRMC (Recommended minimum data for gps) sentences received from GNSS module.
- **GPRMB** - outputs Recommended minimum navigation info.
- **LXWPx** - outputs LXWP0 (flight data), LXWP1 (device info), LXWP2 (basic parameters), LXWP3 (detailed parameters) sentences.
- **LXDT** - enables LXDT (data transfer) communication (input and output)
- **LXBC** - outputs LXBC (broadcast) sentences (AHRS data, etc.)
- **PFLAx** - Flarm sentences, includes "PFLAU", "PFLAA", "PFLAC", "PFLAE", "PFLAL", "PFLAQ". For individual sentence specification check Flarm documentation.
- **Levil** - reserved for use with Levil devices.
- **Radio** - when Radio option is enabled - "On", all other outputs on "User" port are disabled, but are still present via "Bluetooth" port. The following radio transceivers are available:
 - **KRT2**
 - **ATR833**
 - **Becker**
 - **Trig**
 - **AIR avionics**
- **Send APT freq** - confirms whether or not you wish the LX 10k to send the frequency of the selected airport on **Airport navigation page** to the Radio.
- **Transponder** - if enabled - "On", baudrate on "Flarm" port will go to "BR9600" and GPS data will be transmitted on "Flarm" port.

NOTE

In normal use, it is recommended that the **GPGGA, GPRMC, GPRMB, LXWPx, LXDT, LXBC** and **PFLAx** sentences are checked, unless explicitly noted otherwise.

NOTE

For detailed description of **LXWPx, LXDT** and **LXBC** sentences refer to LX Navigation Data Port documentation (document name: **LX_CP**).

5.2.4 Inputs

The Input setup sub-menu refers to the functionalities of the LX 10k closely dependant on existence and proper use of the Inputs interface. The inputs interface incorporates slots for 5 external micro-switches, connected to the Input port on the LX 10k. These micro-switches can trigger different functions and commands, as well as warnings.

The following functions are available:

- **SC** - when assigned and triggered, will change the current flight mode. Check **Flight mode** sub-section for additional info.
- **VP** - changes to vario flight mode, no matter which settings are active
- **event** - triggers the event functions, check **Logger** section for additional info.
- **gear** - if any of the two gear inputs is selected (straight or inverse), the gear warning will be applied in the following sense:
 - gear is out detected 10min after take-off and height more than 500m above take-off location.
 - gear is not out and altitude is less than 200m in 5km circle of take-off location and flight time is more than 5min.
 - on outlanding (if airbrakes are out, elevation less than 600m QFE, distance from take-off more than 5km), and gear is not out. Requires the airbrakes switch to be used.
- **airbrake** - if any airbrake is selected (straight or inverse) gear warning will be announced as follows:
 - airbrake is out during first 10min of flight (take-off / aero tow time).
- **ballast** - triggers the ballast dump rate function, as depicted in **Glider** sub-section.

The Input page requires the use of the **Inputs interface**, shipped along with the LX 10k. We can see the inputs interface on the picture below.

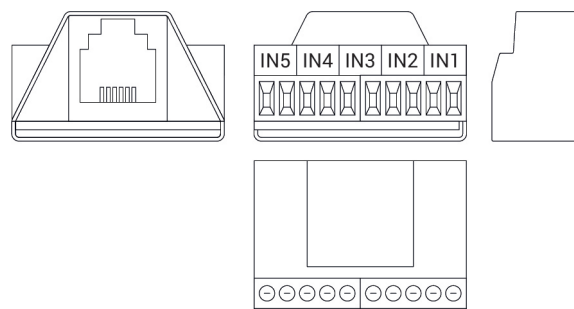

Figure 74.

NOTE

All input functions have an inverse function as well. Having a straight function will trigger once the button has been pressed. Utilizing an inverse function will trigger once the button has been released (useful for air brakes, etc.).

5.2.5 Transfer

The Transfer sub-menu setup page holds all microSD transfer related options. In this setup page, we will see how to transfer database files, load tasks and FlarmNET files.

WARNING

LX navigation provides database files on an informative level and can in no way be held accountable implicitly, or otherwise, for and damage, be it material, personal or other, that may occur due to the use of this device. It is the pilot's responsibility to abide to all rules of air safety and to utilize good airmanship practice. In this sense, the information provided by the LX 10k is of an informative nature only and should be taken with reserve. No guarantees are made on the accuracy of information found in databases released by LX navigation.

WARNING

It is important to note, that some microSD cards of lower quality may cause issues and not be read by the LX 10k. This is why we strongly recommend you use the supplied SanDisk Ultra red/grey micro SD card, supplied with the device, as depicted on the figure below. The microSD card should be formatted to the FAT32 file system. Cards of up to 32 GB of memory were successfully tested on the LX 10k.



Figure 75. The correct type of microSD

NOTE

Pilot must be careful to not exceed the file size of 750 kB, except "FlarmNET" file can be max. 5 MB.

5.2.5.1 Turnpoints

Turnpoint files, in the .cup file format, are not supplied by LX navigation, but can usually be found at competitions, various webpages or from club manager and club mates. As a starting point, you can check the [Open flight maps](#). You can even create your own turnpoint files either by hand, or using different software.

In order to use turnpoint files on your LX 10k, first you need to copy them to the device. In order to do this, you need to have the file saved to the **root of your microSD card**. Once the microSD card is inserted go to **Load** sub-menu and select the file you wish to transfer to the LX 10k's internal memory.

Now go to the **Select** sub-menu and select which of the files in the LX 10k's internal memory you wish to have active.

You can have multiple turnpoint files active at the same time.

NOTE

The LX 10k requires turnpoints in the .cup file format.

5.2.5.2 Airports

Airport files, in the .af file format, are supplied by LX navigation exclusively. For the latest available database files, check the [Database part of LX webpage](#).

The airports file holds the frequencies to all airports, which is why it is especially important to use the latest database files available. If inconsistencies are found in the files, please refer them to the [LX navigation support email](#).

In order to use a certain airport file, first you need to copy it to the LX 10k's internal memory, through the **Load** sub-menu, and then select it as active through the **Select** sub-menu. Only one airports file can be active at a time.

NOTE

The LX 10k requires airport files in the .af file format.

5.2.5.3 Airspace

Airspace files, in the .cup file format, can be found on both the **LX navigation database part of webpage**, as well as supplied by competition directors, club managers, club mates and other readily available database sources.

In order to use a certain airspace file, first you need to copy it to the LX 10k's internal memory, through the **Load** sub-menu, and then select it as active through the **Select** sub-menu. Multiple airspace files can be selected at once.

NOTE

The LX 10k requires airspace files in the .cup file format.

5.2.5.4 Load task

Task files are stored into the .cup file usually, and consequently the same rules apply as for the turnpoint files.

Once opened, the Load task sub-menu will show all .cup files with internal tasks. You can select the desired turnpoint file and a selection of tasks saved to this file will be found. Choosing the task will set the selected task as the current active task.

NOTE

The LX 10k is capable of sending task declarations to external devices (the MOP, Flarm, etc.). This happens when one of the following conditions is met:

- The LX 10k receives a task from an external device through the User port
- The LX 10k receives a task from an external device through Bluetooth
- The LX 10k receives a task from a .cup file through the Load task menu
- Whenever we exit the task edit page in the **Task navigation page**.

NOTE

The LX 10k requires task files in the .cup file format.

5.2.5.5 Flarm NET

The LX 10k allows the utilization of **Flarm NET databases**. If a database is used, and a Flarm object with a Flarm ID found in the database shows up, the LX 10k will automatically use the info from the FlarmNET database and assign it to the said object.

5.2.6 Network

This part of the manual will only go through the settings available in the Network sub-menu part. For information on how to connect to different devices and utilize the LX 10k's connectivity capabilities, please check the **Connectivity** section of this manual.





The LX 10k has a single module used for both Wifi and Bluetooth. The module has five different available states:

- **Off** - no connectivity options are available
- **Bluetooth server** - is used for transmitting data to an external device - like an Android phone or PDA/PNA device. The external device needs to connect to the LX 10k in order to establish communication.
 - The wireless setup will show the device name and password.
- **Bluetooth client** - is currently not available for use. Once enabled, will give the LX 10k the possibility to connect to an external Bluetooth device.
 - The wireless setup will show a list of available devices for connection.
- **WiFi Access point** - is currently not in use. Once enabled, will give the LX 10k the possibility to stream data through the WiFi network.
 - The wireless setup will show the device information and offer the user to change WiFi name and password of the LX 10k's WiFi.
- **WiFi Client** - is used for connecting an LX 10k to a WiFi network. Once connected, the LX 10k is able to communicate with the world wide web and send flights via emails.
 - The wireless setup will show a list of available devices for connection.

This setup also includes the email setup page. Once opened, you are presented with a set of email-related options.

You can create and activate multiple emails at once. When a flight is chosen for sending over the email in the **Logbook/Flight statistics page**, it will be sent to all active emails.

When connecting to a device, either through Bluetooth, or WiFi, an icon to the right of the device names is shown. This icon shows what is the state of the device connection, or it's signal strength.

- | | |
|--|---|
| <ul style="list-style-type: none"> • Strong signal -  • Medium signal -  • Weak signal -  | <ul style="list-style-type: none"> • Connecting -  • Password required for network -  |
|--|---|

In general, all available devices are shown under the 'Available list'. If the LX 10k is connected to a device, it will be shown under the 'Connected' list.

NOTE

If you are connected to a WiFi network, it is displayed under the 'Connected' list. Pressing on the connected network will make the device disconnect from this network.

5.2.7 Localisation

Contains information regarding the local settings of the LX 10k. In this setup menu the language of the device, timezone and a check box for daylight saving time can be set.

At this moment, the following languages are available:

- **English**
- **Dansk**
- **Deutsch**
- **Italiano**
- **Nederlands**
- **Norsk**
- **Slovenščina**

If you wish to contribute and add your language, contact us at [LX support](#).

5.2.8 Synchronisation

The synchronisation setup is reserved for devices in double-seater configuration, when a front and back (main and repeater, also known as master and slave) unit exists.

This Setup page allows the pilot to utilize the following options:

- **Sync on change** - will sync all navigation points (TP, APT and TSK), whenever the front seat unit changes a navigation point, to the back seat unit. Is bidirectional (can also send from second seat unit to front seat unit, if selected on the second seat unit).
- **Sync TP now** - will send the current turnpoint chosen on the main unit's TP navigation page to the repeater unit. Is bidirectional (can also send from second seat unit to front seat unit, if selected on the second seat unit).
- **Sync APT now** - will send the current airport chosen on the main unit's APT navigation page to the repeater unit. Is bidirectional (can also send from second seat unit to front seat unit, if selected on the second seat unit).
- **Sync task now** - will send the current task chosen on the main unit's TSK navigation page to the repeater unit. Is bidirectional (can also send from second seat unit to front seat unit, if selected on the second seat unit).
- **Sync database** - will send the **active** database files from the [Transfer](#) setup menu of the front to the back seat unit.

5.2.9 Service

The Service setup page contains various device and service related settings, as noted below:

- **Device info** - shows basic information regarding the LX 10k:
 - **Serial number**
 - **IGC number**
 - **Firmware version**
 - **Build**
 - **Hardware version**
 - **Odin version**
 - **Battery** - voltage of internal battery
- **Flarm info** - shows additional info related to the connected Flarm device
 - **Hardware version**
 - **Serial number**
 - **Firmware version**
 - **Database**
 - **Database exp. date** - database expiration date
- **CAN unit Info** - shows a list of all device on the CAN line, with their appropriate software and hardware versions.
- **Password** - opens up the dialog for admin passwords, like the one for **Club mode**
- **Club mode** - explained separately below
- **Cage AHRS** - sets the current horizon and pitch angle as zero pitch and zero bank.
- **Software update** - used for updating the device. For further information, check the **Performing an update** sub-section for additional info.

The following passwords are at the pilot's disposal:

- **46486** - Deletes all internal files (database files, pilot information, etc.) Can be considered as reverting the device to factory settings.
- **99999** - Empty logbook
- **08658** - Voltage offset setup
- **02582** - Club manager setup database

5.2.9.1 Club mode

The Club mode is used for setting up Club pilot profiles and editing them. By 'Club' we mean generic pilot profiles, which are password protected and can only be changed by a 'Club manager'. Regardless, the same procedure can be used to password protect any pilot profile.

Even though a profile is set as a 'Club profile' changes will still be made, but not saved, if not in 'Club mode'. For a detailed explanation, check the text below.

Engaging the Club profile:

1. Go to Setup > Service > Password and type in '02582'
2. Mark 'Club mode' under 'Service'
3. Go to Pilot > mark 'Club profile'

The logic behind the club profile is that with this procedure, you lock it as is. However, this does not mean that the profile can not be changed, but rather that no changes are permanent, and after restart the changes will revert to the state you had your profile in, when it was locked with the password.

Lets say you create your profile and set everything up. You lock it (set it as Club profile) with the procedure above. Then after a few days another pilot flies the plane and wants to use your profile, as it is a good one, but would like to change one thing, like the reserve altitude. He can go to the Setup and change the reserve altitude and the system will use his reserve altitude as long as it is turned on. This means he can go and fly and use the settings that he altered. After he lands, extracts the flight and turns the device off, the settings will revert to the ones you have set, so the next time you go flying, the reserve altitude will be the one you've set for yourself.

The only way to change your settings for good is to again type in the above password, and then change them. The password is meant for a club administrator ('admin').

NOTE

If a new pilot profile is added, while in Club mode, it will not be saved, after the device has been restarted.

5.2.10 Shutdown

Performs the shutdown sequence for the device.

WARNING

If select while in flight, the LX 10k will finish the flight and shut the device off.

Connectivity

This section will go through how to set up different types of connections. By connections, we mainly mean different means of communication between the LX 10k and third party devices.

6.1 WiFi connectivity

At this moment, the WiFi connectivity option on the LX 10k is used solely for sending .igc flights to emails. New features will be rolled out soon.

6.1.1 Flight transfer

In order to be able to send a flight, the following settings need to be set up:

1. **An e-mail address** needs to be set up
2. **A WiFi connection** needs to be established
3. **A flight** needs to be available in logbook
4. **You can not be in flight mode**

6.1.1.1 Setting up an email address

To set up an email address, go to **Setup > Network > Mail > Add mail**. Use the alphanumeric keyboard to type in your email address (Caps lock insensitive). Multiple email addresses can be set up at once.

Once set, select which email addresses you wish to have active. Having them active means the flight will be sent to these addresses.

6.1.1.2 Establishing a WiFi connection

To set up a WiFi connection, go to **Setup > Network > Wireless mode** and choose **WiFi Client**.

Exit the **Wireless mode** setup by going back and open the **Wireless setup** menu. You will find a list of WiFi networks listed under 'Available'. If the device is not connected to a WiFi network, there will not be a Wifi Network listed under 'Connected'.

Select the desired WiFi network and a new page will pop-up, giving us the option to type in the **Password**, **Forget** the network or **Connect/Disconnect**. Type in the password (Case-sensitive) and select the **Connect** option.

You will now see the icon symbolizing the connecting attempt -  and a the shift of the WiFi network name to the 'Connected' list, if the connection attempt is successful.

6.1.1.3 Sending the flight

To send a flight, go to the **Logbook** page, and select the flight you wish to send. Once the 'Flight info' sub-page has popped up, scroll down and choose the **Send to email** option.

The LX 10k will prepare the flight for sending, a 'Preparing data' infobox will appear, and a second infobox, showing an hourglass. Once the flight has been sent, an infobox notifying you of the successful upload will appear.

Now, **check your email**.

6.2 Bluetooth connectivity

Bluetooth connectivity is used mainly for the transfer of data. Data in the sense of NMEA sentences.

Practically, this means supplying data like wind information, IAS, vertical speed, altitude, etc. This data is then used by the 3rd party device for more exact calculations.

Also, a Bluetooth connection allows a third party device to send a declaration to the LX 10k, as well as changing different settings, like MC, ballast and bugs.

We will look over two cases, an Android phone (XC Soar) and an Oudie, as these represent Android applications and different PDA/PNA devices, respectively.

6.2.1 Connecting an Android device (XC soar)

In order to connect an Android phone, the following steps are required:

1. **Establishing a Bluetooth connection**
2. **Setting up the LX 10k**
3. **Setting up XC Soar**

6.2.1.1 Establishing a Bluetooth connection

To set up a Bluetooth connection, go to **Setup > Network > Wireless mode** and choose **Bluetooth server**.

Exit the **Wireless mode** setup by going back and open the **Wireless setup** menu. You will find your device's Bluetooth name and password, needed fro establishing a Bluetooth connection.

Now take your Android phone, turn the Bluetooth on and check the 'Available devices' list. You should see your LX 10k. Select the LX 10k and the connection will be established.

6.2.1.2 Setting up the LX 10k

To set up LX 10k NMEA communication, needed for the proper functioning of XC Soar, go to **Setup > NMEA** and check the following tick boxes:

- **GPGGA**
- **GPRMC**
- **GPRMB**
- **LXWPx**
- **LXDT**
- **LXBC**
- **PFLAx**

Your LX 10k will now send the checked NMEA sentences to the Android phone.

6.2.1.3 Setting up XC Soar

Open XC Soar on your phone, go to **Config > Devices > B: > Edit** and set up the following items:

- **Port** - select the port with the same name as your LX 10k's Bluetooth name (LX LX 10k 3xxxx)
- **Driver** - LX navigation (pending)
- **Passthrough device** - Off

Once done, you should see the connection state go from 'Not connected' to 'Connected; Baro; Airspeed; Vario; FLARM'.

Now the two devices are communicating.

6.2.2 Connecting an Oudie or other PNA/PDA device

In order to connect an Oudie, or similar PDA/PNA device, the following steps are required:

1. **Establishing a Bluetooth connection**
2. **Setting up the LX 10k**
3. **Setting up the Oudie**

6.2.2.1 Establishing a Bluetooth connection

To set up a Bluetooth connection, go to **Setup > Network > Wireless mode** and choose **Bluetooth server**.

Exit the **Wireless mode** setup by going back and open the **Wireless setup** menu. You will find your device's Bluetooth name and password, needed for establishing a Bluetooth connection.

Now take your Oudie, go to **Menu > Settings > Input > Bluetooth...** and press Lookup. The Oudie will now search for nearby Bluetooth devices. Once your LX 10k appears (LX LX 10k

34xxx), select it and press pair. When prompted for a password, type in '1234'.

The following settings should be set:

- **Port** - COM5: (Bluetooth)
- **Speed** - 38400
- **Parity** - None
- **Bits** - 8
- **Stop bit** - 1
- **Set DTR** - Checked
- **Set RTS** - Checked

Press OK and the Oudie will exit back to the main screen.

6.2.2.2 Setting up the LX 10k

To set up LX 10k NMEA communication, needed for the proper functioning of XC Soar, go to **Setup > NMEA** and set the NMEA baud rate to **38400**.

Now check the following tick boxes:

- **GPGGA**
- **GPRMC**
- **GPRMB**
- **LXWPx**
- **LXDT**
- **LXBC**
- **PFLAx**

Now go to the Oudie's **Menu > Settings > Hardware > Device** and select 'LX navigation' (pending).

If you go to the Terminal, you should see communication flowing, in the form of NMEA sentences.

Now your devices are communicating.

The Oudie will receive various flight parameters (IAS, vario info, Flarm objects and warnings, GPS, etc.) from the LX 10k, and the Oudie will be able to send a flight declaration to the LX 10k and control various flight parameters, like MC, bugs and ballast.

6.3 User port connectivity

Various devices can be connected to the LX 10k's User port. The User port is used for bidirectional NMEA communication, using the RS 232 protocol. Since the list of devices is long, we will go through two main examples, an Oudie and a KRT2 radio, representing PNA/PDA devices and radio transceivers, respectively.

6.3.1 Connecting an Oudie

The main benefit of a wired connection between the Oudie and LX 10k is that the LX 10k will charge the Oudie, for as long as the LX 10k has an external power supply. Also, if you wish to connect two Oudies to an LX 10k, you can do this by connecting one device via Bluetooth and the second device via cable.

For a cabled connection, you will need an **LX LX 10k Power & Data cable**. Connect the PowerData cable to the Oudie, set the input on the Oudie to COM4, serial cable and set the same NMEA sentences as mentioned earlier for Bluetooth communication.

6.3.2 Connecting a Radio

When connected to an LX 10k, a radio transceiver can receive airport frequency information from the LX 10k and set it as the reserve frequency.

The following radios are supported:

- **KRT2**
- **ATR933**
- **Becker**
- **Trig**
- **AIR avionics**

The Radio transceiver needs to be connected to the LX 10k User port, utilizing the RS232 communication protocol. Hardware installation will be explained in the '**LX 10k installation manual**'.

On the software side, the LX 10k needs to have the correct radio chosen in the **Setup > NMEA > Radio**, and the 'Send APT freq.' checkbox checked.

Vario Indicator Unit

The LX 10k is a system consisting of two devices. The first one, the LX 10k main unit, has been the centre of our attention. This section will turn our attention towards the second device - the **Vario Indication Unit**.

The LX 10k comes with one of three different devices, available as a vario indicator unit. The **digital vario indicator 57**, the **digital vario indicator 80** and the **analog vario indicator 57**.

The '57' and '80' represent the size - the diameter of the hole in millimeters, which the instrument fits, and digital/analog represents the type of vario needle, the instrument utilizes. The differences are much broader, than just the vario needle type, as the digital vario indicator is based on one hardware platform - the Era (57 & 80), while the analog indicator is based on the Eos 57.

The only difference between the two digital units is the size. The functions, functionalities and features are absolutely the same, due to the same hardware and software they share.



Figure 76. Digital vario indicator



Figure 77. Analog vario indicator

7.1 The digital vario unit

The digital vario unit has three main pages:

- Main page
- Thermal assistant page
- Vario setup page

The digital vario unit has a single push-rotary knob, labeled with a loudspeaker. This push-rotary is used for commanding the indicator in two ways:

- **Rotating** the push-rotary will change the volume of the vario/SC tune
- **Pressing** the push-rotary shortly will transition to the Thermal assistant page
- **Long-pressing** the push-rotary knob for 2 seconds will open the Setup menu on the vario indicator unit.

7.1.1 Main page

The main page holds primary flight information. It consists of the digital needle scale, which is shown on all pages, a clock, either two or four user settable indicators, status indicators, a wind indicator and an OAT indicator.



Figure 78. Main page overview

7.1.1.1 Digital needle scale

The digital indicator does not use a needle-type pointer for showing values on the circular scale, but rather a solid colour.

Positive values are shown with a solid red arc, ranging from 0 to the actual value. **Negative values** are shown with a solid blue, ranging from 0 to the actual value. The solid arcs with their large surface and potent colours help show the desired values in a very clear attention-drawing manner. The impact of solid area digital needles is shown with the two figures below.



Figure 79. Red digital needle scale



Figure 80. Blue digital needle scale

The digital needle scale can be set in the **Indicators** menu to shown one of the following flight parameters:

- **Vario**
- **SC**
- **Netto**
- **Relative**
- **G-force**

For more information on how to set the digital needle, check the **Indicators** part of the manual.

The value, which is being shown by the digital needle, is shown with three letters bellow the status indicators, shown as 'VAR' on figure 98.

If the the -5 to +5 m/s vario scale is chosen, and you experience a lift larger than 5 m/s, the vario needle will go up to the number 5, but the number 5 on the scale will change to the exact vario value, you are experiencing at that moment, as shown by the two figures above.

The digital needle scale shows two additional parameters: **Speed to fly** and **MacCready** value set.

The first is represented with a thin green line, which moves along the inner edge of the digital needle scale. The idea is that the green arc should always be on zero. If it is showing a negative value, it means you are flying to slow for the current vertical speed value and MacCready value set, and that you should speed up. Similarly, if the green arc is showing a positive value, it means you are flying too fast and you should slow down. When abiding to Speed-To-Fly rules in your flight, in ideal conditions, the green arc is not visible.

The latter shows the current MacCready value set and is represented with a yellow dot with black outline. If the dot is positioned on the 2 m/s value, it means your current MacCready value is set to 2 m/s.

7.1.1.2 Digital numeric indicators

The digital indicator's main page features either two or four numerical indicators. If two indicators are chosen, the info shown is twice as large, which is why this setting is recommended with pilots who have short-sightedness issues.



Figure 81. Four indicators on a white background theme



Figure 82. Two indicators on a black background theme

Each of these indicators is formatted in the same way. On the far-left, the name of the indicator is displayed, noting which flight parameter the indicator is showing. Next, with larger fonts, the actual value is shown, with the value unit to the right of the shown value. These indicators are the only pilot-adjustable fields on this page, apart from assigning the flight parameter the digital needle arc will show.

Pilots can choose between the number of indicators, which indicators will be shown, as well as a separate set of indicators for both **Flight modes** (circling and straight flight).

For more info on how to set the numerical indicators, check the **Indicators** setup menu.

7.1.1.3 Current time and OAT

These indicators embody the central part of the screen from the top and bottom, respectively. The Current time indicator shows the current GPS time in regards to the timezone chosen in the **Localisation** setup menu. The OAT indicator shows current Outside Air Temperature, or more exactly, the temperature measured by the OAT probe. This item is non-configurable.

7.1.1.4 Flarm status indicator

Is represented with a red Flarm symbol, depicted with **Flarm status indicator icon**. If the Flarm icon is present, the device has an established connection with a Flarm device. On how to get more info from the Flarm device, check the **Info page** section. For information about Flarm objects and the Flarm radar page, check the **Flarm radar page**.



Figure 83. Flarm status indicator icon

7.1.1.5 Connectivity status indicator

The LX 10k has both Bluetooth and WiFi capability. Both modes are depicted with an appropriate icon.



Figure 84. Bluetooth status indicator



Figure 85. WiFi is on indicator



Figure 86. WiFi is connected indicator

The Bluetooth icon indicates the current wireless mode is set to Bluetooth. The WiFi icon shows in two colours. A black WiFi icon indicates the wireless mode as set to WiFi, while the green WiFi icon indicates that we have established a connection. For more information on connectivity, check the **Connectivity** section.

7.1.1.6 GPS status indicator

The GPS status indicator indicates whether or not the device has a valid GPS lock. Under valid GPS lock, a connection to at least four satellites is required.



Figure 87. GPS signal is not valid



Figure 88. GPS signal is valid

7.1.1.7 Flight mode status indicator

The flight mode indicator depicts whether the device is currently in straight flight, or circling mode. The common way to transition between the two modes is by activating the SC (Speed Command) button/switch, or by using one of the automatic ways, implemented into the device.

For additional information on how to setup different input switches, check the **Inputs** section. For additional info on how to change between flight modes automatically, check the **Vario/SC** setup menu.



Figure 89. Device is currently in circling mode



Figure 90. Device is currently in straight flight mode

7.1.1.8 Battery status indicator

White battery outline indicates the device is running on external power, while a red battery outline indicates the device is running on internal power.



Figure 91. 1 red bar (less than 10.8V)



Figure 92. 2 yellow bars (more than 10.8V)



Figure 93. 3 green bars (more than 12.0V)



Figure 94. 1 red bar (less than 20 % backup battery left)



Figure 95. 2 yellow bars (21 - 80 % backup battery left)



Figure 96. 3 green bars (81 - 100 % backup battery left)

7.1.1.9 Wind indicator

The wind indicator shows three important wind parameters. Firstly, it shows the wind direction relative to our current track, with the black/green arrow indicator shown by figure 97. Right to the wind circle, wind absolute direction is shown, as well as the wind speed, along with the speed units. For info on how to set units, check the **Units** setup menu.



Figure 97. Wind relative direction indicator

The wind is being calculated both in circling and in straight flight. It will update at all times and no settings are required.

7.1.1.10 Volume setting

A pilot can change volume in two ways:

- **Turning the Volume push-rotary knob** on the vario indicator unit
- Going through the MC sub-page on the main unit, as described earlier

Once the Volume sub-page is open, you can close it by pressing the push-rotary knob on the digital vario indicator, or by waiting for 3 seconds for it to auto-close.

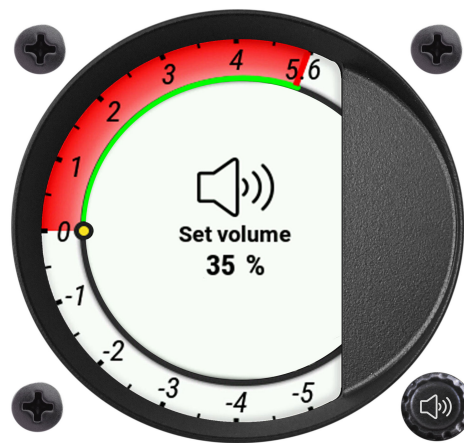

Figure 98. Volume setting

7.1.2 Thermal assistant page

The Thermal assistant page on the digital vario indicator is very similar to the one already described previously for the main unit. The main difference is the upright orientation of the screen, the lack of the altitude sliding tape and the presence of the vario arc.

The TA page incorporates four NavBoxes, showing the following parameters:

- **T AVG** - shows the average vertical speed for the whole thermal, since the device detected the start of circling, up to the current point in time
- **AVG** - shows the integrated vertical speed for the time duration set in the **Vario/SC** setup menu
- **MAX** - the maximum variometer value in the last circle (360 degree turn). This is the same value as is represented by white dot on TA page.
- **GAIN** - shows the accumulated altitude from the start of circling. The GAIN NavBox shows the difference between current altitude and altitude recorded at the start of circling, which means this value can also be negative.

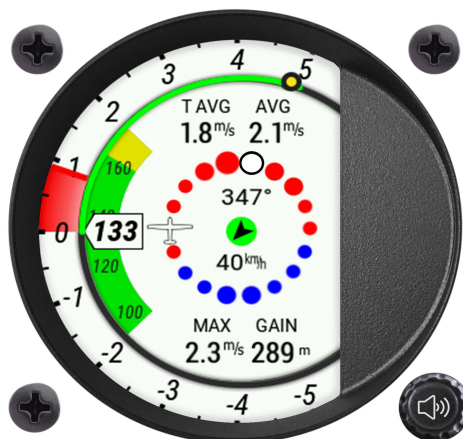

Figure 99. Thermal assistant page overview

In the middle of the screen, we can see the actual **Thermal assistant**, embodying the **Wind indicator**. The Wind indicator works much the same as already noted in **Wind indicator**.

The **Thermal assistant** is an indicator, whose main function is to map the strength of the thermal in the last full circle and give the pilot an idea of his actual position in the thermal, thus helping him center.

A glider represents the pilot's current position in the thermal. The glider can be either on the left side (circling to the right), or the right side (circling to the left) of the Wind indicator.

Next we see dots forming a circle, at 18 degree intervals. These dots represent discretized parts of the thermal. The dots are either red or blue. Red indicates a lifting part of the thermal and blue a sinking part. The size of the dot indicates the intensity, larger dots representing greater vertical speeds, in either direction. A single dot (white when dark theme is used and

white with a black edge when light theme is used) represents the strongest part of the thermal during your last circle.

To the left of the Thermal assistant, we can see a colour arc, indicating IAS. The current IAS is framed, and behind it sliding colour arcs can be seen. The colour arc boundaries can be set in the **Glider** section.



Figure 100. TA options overview

Additional settings for the thermal assistant can be accessed through the **Vario setup page**

7.1.3 Vario setup page

To access the Vario setup page, long-press the volume push-rotary knob on the vario unit for at least 3 seconds.

Here, the following menu pages are available:

- **Graphics**
- **Thermal assistant**
- **Service**
- **Shutdown**

7.1.3.1 Graphics

Theme

The Theme sub-menu offers the pilot to choose between 4 themes. The Era features has two areas for themes - the vario scale and the internal part (everything inside of the vario scale). For each of these two a white or black option is available, giving us four combinations.

The first colour indicates the colour of the central part of the display, and the second colour indicates the digital needle part of the display:

- **Black and white** - black center and white needle arc
- **Black and black** - black center and black needle arc
- **White and white** - white center and white needle arc
- **White and black** - white center and black needle arc

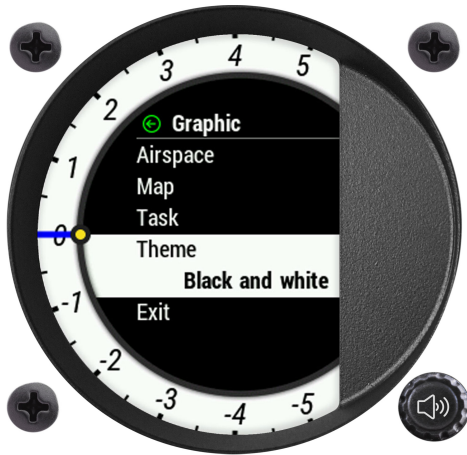

Figure 101. Black and white theme



Figure 102. Black and black theme



Figure 103. White and white theme



Figure 104. White and black theme

WARNING

Changing the theme will cause the unit to instantly restart, with a prior question on whether or not you wish to reboot. Due to this reason, changing the theme in flight is not possible.

NOTE

Experience has shown that in high sunlight conditions, the 'White and white' colour theme is most visible, while the 'Black and black' colour theme is least straining for the eyes in low light conditions. Of course, sometimes it is just a matter of taste, which means De gustibus non est disputandum.

7.1.3.2 Thermal assistant

This menu holds additional settings for the thermal assistant page for the digital variometer. The setup options for the thermal assistant page is the same as described previously for the main unit.

- **Auto TA** - Ticking this option will make the Era turn to TA page when it detects circling has started. Once the Era detects it is no longer circling, it will revert back to the page you had before.
- **MC color** - When MC color scheme is ticked, red dots represent climb which is stronger than 1.2*MC value set. Yellow dots represent climb in range of 0.8*MC and 1.2*MC value set. Blue dots represent climb less than 0.8*MC value. If MC setting is less than 0.5m/s, default color scheme is used.
- **Max beep** - The device beeps when you are passing through the point at which the maximum thermal strength was recorded in your last turn.
- **Beep offset** - Offsets the beep by a set amount of seconds.

7.1.3.3 Service

The Service setup page contains various device and service related settings, as noted below:

- **Device info** - shows basic information regarding the Era:
 - **Serial number**
 - **IGC number**
 - **Firmware version**
 - **Build**
 - **Hardware version**
 - **Battery** - voltage of internal battery
- **CAN unit Info** - shows a list of all device on the CAN line, with their appropriate software and hardware versions.
- **Password** - opens up the dialog for admin passwords, like the one for **Club mode**

The following passwords are at the pilot's disposal:

- **46486** - Deletes all internal files (database files, pilot information, etc.) Can be considered as reverting the device to factory settings.

7.1.3.4 Shutdown

Performs the shutdown sequence for the device.

7.2 The analog vario unit

By contrast, the analog vario unit is much simpler, offering only one screen and no settings on the device itself.



Figure 105. Analog vario indicator

7.2.1 Volume setting

A pilot can change volume in two ways:

- **Turning the Volume push-rotary knob** on the vario indicator unit
- Going through the MC sub-page on the main unit, as described earlier

Once the Volume sub-page is open, you can close it by pressing the push-rotary knob on the digital vario indicator, or by waiting for 3 seconds for it to auto-close.

7.2.2 Mechanical needle

The device consists of an analog (mechanical) needle, which can also be assigned different to show different flight parameters, in both circling and straight flight modes:

- **Vario**
- **SC**
- **Netto**
- **Relative**
- **G-force**

The actual scale of the mechanical needle and the units in which the values are displayed, are shown in the far top-right corner of the screen. These can be set to different values, although the markings on the physical scale will stay the same and are set at the factory in regards to the customer's requests.

Outlining the edge of the screen, towards the needle, is the Speed To Fly arc (coloured in green). This arc functions the same as already described previously for the digital indicator.

7.2.3 Digital indicators

The analog indicator's main page features two numerical indicators. Each of these indicators is formatted in the same way. On the far-left, the name of the indicator is displayed, noting which flight parameter the indicator is showing. Next, with larger fonts, the actual value is shown, with the value unit to the right of the shown value. These indicators are the only pilot-adjustable fields on this page.

The digital indicators are set in the main unit setup, as described in the **Indicators** setup menu.

7.2.4 Status indicators

7.2.4.1 Wind indicator

The wind is indicated in on the left of the central part of the screen. Unlike the digital vario indicator, no green/black arrow is present for showing relative wind direction. The wind is only shown in speed and absolute direction.

The wind is being calculated both in circling and in straight flight. It will update at all times and no settings are required.

7.2.4.2 Flarm status indicator

Is represented with a red Flarm symbol, depicted with **Flarm status indicator icon**. If the Flarm icon is present, the device has an established connection with a Flarm device. On how to get more info from the Flarm device, check the **Info page** section. For information about Flarm objects and the Flarm radar page, check the **Flarm radar page**.



Figure 106. Flarm status indicator icon

7.2.4.3 GPS status indicator

The GPS status indicator indicates whether or not the device has a valid GPS lock. Under valid GPS lock, a connection to at least four satellites is required.



Figure 107. GPS signal is not valid



Figure 108. GPS signal is valid

7.2.4.4 Flight mode status indicator

The flight mode indicator depicts whether the device is currently in straight flight, or circling mode. The common way to transition between the two modes is by activating the SC (Speed Command) button/switch, or by using one of the automatic ways, implemented into the device.

For additional information on how to setup different input switches, check the [Inputs](#) section. For additional info on how to change between flight modes automatically, check the [Vario/SC](#) setup menu.



Figure 109. Device is currently in circling mode



Figure 110. Device is currently in straight flight mode

7.2.4.5 Battery status indicator

White battery outline indicates the device is running on external power, while a red battery outline indicates the device is running on internal power.



Figure 111. 1 red bar (less than 10.8V)



Figure 112. 2 yellow bars (more than 10.8V)



Figure 113. 3 green bars (more than 12.0V)



Figure 114. 1 red bar (less than 20 % backup battery left)



Figure 115. 2 yellow bars (21 - 80 % backup battery left)



Figure 116. 3 green bars (81 - 100 % backup battery left)

LX Joy

The **LX Joy** (short for Joystick) is a remote control unit for the LX 10k, which attaches to the aircraft's flight control stick. Using the Joy with the LX 10k, you can access all available settings, without touching the LX 10k itself.

Please note that the **LX Joy** is shared between the LX 10k, LX Eos and LX Era units. Since not all of the buttons are required for the full operation of the LX 10k, some LX Joy buttons are without functions (**VOL**).

In general, the Joy input interface consists of five front-facing push buttons, a central pentadirectional (up, down, left, right and push) joy button, a front facing LED and a SC push button on the back side (facing the instrument panel).

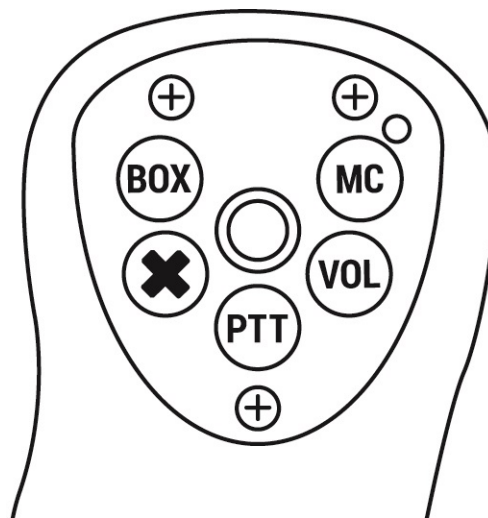

Figure 117.

The central button is used for main navigation throughout the LX 10k OS. It mimics the turning of both the left and right push-rotary knobs and pressing the right push-rotary knob, in the following way:

- **Left/Right** - mimics turning the right push-rotary knob
- **Up/Down** - mimics turning the left push-rotary knob
- **Pressing** - mimics pressing the right push-rotary knob

The MC button will mimic the pressing of the MC button on the LX 10k.

The **BOX** button will mimic the pressing of the BOX button on the LX 10k.

The **'X'** button will mimic the pressing of the left push-rotary knob on the LX 10k.

The **PTT** button is connected to the Radio and does not influence the LX 10k.

NOTE

The LX 10k is not compatible with the legacy LX Remote Stick.

NOTE

The BOX push button and the LED are without function when in use with the LX 10k. The LED is reserved for use with a Zeus, while the BOX can be used either by an LX 10k or with a Zeus.

NOTE

Newer **LX Joys** feature a Vibra motor, giving the pilot not only audio and visual warnings, but vibration warnings as well.

NOTE

There are different HW iterations of the current **LX Joy**. LX 10k is compatible with all of them, although older and Zeus-type **LX Joys** will have different button icons. Nevertheless, the functions of those buttons will stay the same as described in this section.

NOTE

New hardware versions of the LX Joy utilize SC switch communication over the CAN cable, and thus lack the two wires going from the Joy to the LX 10k's Inputs interface. Older hardware versions of the LX 10k will require the SC command button be connected to the Inputs interface. For additional info, check the **Inputs** section

Taking care of your LX 10k

If you were taken here by following the link from the introductory part of this manual, you can get back by clicking on the underlined text - [Using this manual](#).

9.1 The internal battery

The LX 10k has a Li-Ion internal battery, used for powering the unit, if the main power supply of the plane gets cut, during flight.

The internal battery can power the LX 10k from **3 to 5 hours**, depending on the brightness level, whether wireless is on, volume and the state of the battery.

To extend the longevity of your LX 10k's battery a few key steps should be taken:

- **Avoid using the internal battery, when not needed** - Do not intentionally cut the power to the LX 10k, when there is still enough power from your main batteries. Do not intentionally leave it in flight mode.
- **Avoid draining the internal battery** - Draining the battery completely is a known culprit for reducing battery capacity. If you see the LX 10k changed to its internal power supply, think about heading to your home airfield, unless on a competition of course!
- **Proper winter storage** - During periods of long inactivity, especially during winter, when cold temperatures are present, the battery capacity is lowered by cold temperatures and it can easily happen that the battery gets completely drained, causing the LX 10k to lose its seal and the battery to lose part of its capacity. To avoid this from happening, it is recommended that, whenever the LX 10k is in storage, it should be connected to an external power supply regularly, every 4 to 6 weeks, for at least 3 hours, for the internal battery to charge.

NOTE

The LX 10k can not power external devices, while on internal power, meaning Flarms, User port connected PDA/PNA devices and CAN connected devices will stop working (unless they have an internal power supply of their own).

NOTE

The LX 10k charges the internal battery automatically, when connected to an external power supply.

WARNING

Draining the battery completely will cause the LX 10k to lose its IGC seal. If this happens, the pilot will be prompted by a red warnings stating 'Seal not valid!', when powering up the device. All flights recorded without a valid seal will not be IGC valid, meaning they can not be used for badge flights, record flights, competition flights and webpages like OLC will not calculate them into your cumulative score. If this happens, contact [LX support](#) as soon as possible.

9.2 Pressure sensors

The LX 10k incorporates a variety of delicate pressure sensors. Since these are zero-flux sensors (there is no airflow through the sensors, only pressure differences), no air filters are required.

Static pressure sensors have an operating range of 0 to 1200 mbar, with a high resolution of 20cm of altitude. Any overpressure could damage the static pressure sensor permanently, which is why great caution should be exercised when setting up and testing the pitot-static system. If the total pressure were to be connected to the static port, and a pilot was to check the IAS reading by blowing into the pitot tube, damage could easily occur.

The differential pressure sensor has an operating speed of up to 325 km/h (50hPa). Flying over this speed, or applying the equivalent pressure, may damage the sensor permanently.

9.3 Display

Leaving the glider canopy open in the sun is known to have a magnifying glass effect, concentrating the sun rays to a smaller area. This can damage the internals of your cockpit, as well as the display of the LX 10k. Applying excessive heat will make the coating of the display start to become yellow and bubble (best case scenario), or destroy the device completely.

This is why it is prudent to always have your canopy, or your instrument panel, covered from direct sunlight.

9.4 Device housing

By FAI IGC rules, visible external damages to the housing of the LX 10k can void your competition, record or badge flight, from being processed as valid. Care should be taken not to damage the housing and the 'Data not valid if seal is broken' stickers not to be torn up.

9.5 RJ connectors

RJ connectors (RJ12 and RJ45) on the back of the LX 10k are used for connecting external devices. If the cable is pulled out, without pressing the plastic security pin, the internals of the

LX 10k's connector may break and get ripped out. One should always be careful when taking the cable out, to press the security pin completely.

9.6 MicroSD card reader

The LX 10k features a microSD card reader on the front of the device. The microSD should always be inserted carefully, not to miss the internal microSD card reader electronics.

9.7 Reverse polarity on power

Although the LX 10k has diodes protecting it from reverse polarity on the main power lines, one should note the RJ connectors are not protected and internal electronics could still get damaged, if a power supply is connected to the wrong pins on the RJ connectors. Similarly, the LX 10k can damage external devices, if a wrong cable is used for connection, as the LX 10k provides a 12VDC power supply to the CAN, Flarm and User ports.

Release notes

10.1 1.6.151/6508 (2020-07-14)

- Displaying "Select from the list" instead of empty field for Select TP/APT/AS item in Transfer menu

10.2 1.6.142/6504 (2020-07-06)

- Added Watchdog reset to waypoint sort loop on NRST page (possible fix for NRST page crashes)
- Delete task on 2nd seat if deleted on 1st and vice versa if Sync on change is enabled.
- Change for changing MC, bal, bugs on 2nd seat not being sent to user port via LXDT.
- Change for not sending MC, bal, bugs during editing.
- Change for APT freq. voice not being played if new APT received from 2nd seat (sync)....
- Total and remaining distance show "—" instead of 0.0 (when route not selected)

10.3 1.6.136/6495 (2020-07-02)

- Fix for voice output stuttering if initial page finished before "Set QNH" audio has been played to the end
- Fix for BT and WiFi status icons not being shown correctly on secondary units (including digital vario indicator)
- Circling radius Nav box title renamed from "RAD" to "CIRC RAD"
- Odin version in device info production page
- Additional RAM space optimizations
- Cirrus renamed to Cirrus in glider list
- Added Flarm ID to Flarm info in Setup -> Service menu
- Showing "—" instead of false values for distance, FG, bearing and req. eff. in navboxes when no TP/APT/TSK/NRST is selected.
- Change for Brightness setting. Before it was being synchronized between 1st and 2nd seat device. Now each has individual setting.
- Fix for changing the MC values by the user port via \$LXDT,SET,MC_BAL which changed MC for the primary device only. Now it is sent to 2nd seat also.

10.4 1.6.119/6478 (2020-06-15)

- Optimizing Setup menu for saving RAM space
- AHRS page renamed from PFD back to AHRS in Pages setup
- Added language Italian

10.5 1.6.112/6457 (2020-06-10)

- Protocol extended with additional navigation and sensor data as requested by LK8000 and XC Soar developers

10.6 1.6.110/6453 (2020-06-08)

- Added password for formatting internal SD
- Fix for updating CAN units does not start if maps are disabled in settings.

10.7 1.6.102/6446 (2020-06-02)

- Fix for WiFi BT Server name (SSID) default value longer than max size in settings (issue reported by Marco)
- Fix for crashes on airspace preview

10.8 1.6.100/6441 (2020-06-02)

- Fix for "Delete all files" password not deselecting DB files.
- Fix for wrong SW version in CAN unit info
- Changed conditions for secondary device (including 10k digital vario indicators) shut-down - now it shuts down only if not in flight and without power supply.
- Added Setting to disable maps
- Added languages: German, Danish, Norwegian, Dutch

10.9 1.6.90/6423 (2020-05-27)

- Fix for aircraft icon not syncing to 2nd seat

10.10 1.6.86/6410 (2020-05-25)

- Fix for kg/min unit and minor fixes on other unit characters
- Common text file for Eos 80, Era, 10k, TM and Horizon

10.11 1.6.70/6381 (2020-05-12)

- Minor fixes: "airbreakes" -> "airbrakes"; Indicators setup reordered,

10.12 1.6.49/6367 (2020-05-07)

- Added unit mbar
- Fix for Sort by ICAO
- Minipage statistics fix for Max IAS (before it was current value)
- Added "+" and "," signs to basic keyboard (needed for flap settings)
- Fix for Battery low warning
- Fix for update more than one device over CAN
- Default task zones menu fixed (titles and item visibility)

10.13 1.4.29/6345 (2020-04-28)

- Long update file names enabled.
- AHRS page stripe widgets color fixed on white theme.
- Added "This list is empty" text to Airspace and Logbook page if list is empty.
- Added Flight Manager class for detection of flight phases and landings + corresponding NavBoxes.

10.14 Automated builds (from 2019-06-17 to 2020-04-06)

- Added cage AHRS in Setup -> Service menu
- Warnings -> Altitude renamed to Max. Altitude
- Sending shutdown command (MCS) on main unit shutdown
- Implemented flap position settings
- Improved Timezone select menu
- Added DST
- Low battery warning added
- ICAO code shown on APT/TP details page
- Added navboxes thermal avg, max in gain
- Added popup message when SSID name is changed that WiFi should be restarted for change to take effect
- Fixed map background color according to selected theme
- Default map colors set to more visible on both white and black theme
- Added remove pilot feature
- Black border added to arrows on Flarm page.
- Added option to turn off altitude warning.
- AIR Avionics ACD support.
- Added filter for most important values when saving to model.
- Added polar Technoflug Piccolo.
- Added notifications for red cross on AHRS, Flarm and navigational pages.
- Added setting for sending frequency on APT select.
- TRIG radio support.
- Multiple TP AS file selection supported.
- Selected TP/APT/AS/FlarmNET files setting moved from User to System.
- SC Switch setting moved from Vario/SC to Glider menu.
- Glider Reg Nr, Comp Id, Class settings moved from User to System.
- Improved and simplified Network setup.
- Pilot Copilot synchronization between 1st and 2nd seat (fixes problems with wrong Total mass, STF etc.)
- Task finish altitude implemented.
- New polar added Diamant 16.5
- WiFi symbol in status header coloured green if connected to WiFi.
- Added some additional characters to WiFi password keyboard.
- Ignoring AS warnings for 5 min after take-off.
- AS warning close button is settable in Setup > Warnings -> AS close button.
- Logger start speed is settable in Setup > Logger -> Start speed.

- Support for accepting and syncing mail with Zeus.
- Adding progress, info and warning messages for different states occurring during sending IGC file to email.
- Minor graphical fixes (menu icons).
- Fix for Flarm Net file deselecting on device restart
- Improved graphics.
- Improved airspace warning settings.
- Added new polars.
- Improved distance calculation for task.
- Active TP, APT and task synchronization between 1st and 2nd seat.
- Added Tail drawing on map.
- Added support for new temperature sensors.
- Sending mail implemented.
- We can now send igc file to mail address.
- We can now connect to device with flarm data and receive that data.
- Improvements for bluetooth menu.
- Minor code improvements.
- General bt/wifi improvements.
- Active TP, APT, Task and DB files (TP, APT and AS) synchronization between 1st and 2nd seat.
- Fix on AGL NavBox (showing "—" if elevation not available).
- Statistics page multi color graph and re-positioning elements.
- Display glider position on AS preview page.
- LX NMEA 2.0 protocol: added outputs for McBal, AHRS.
- Task export implemented
- Added glider icon setting
- Setup menu optimization (releases some heap and fixes random crashes)
- LX NMEA 2.0 supported on BT
- Radio commands and data output supported in LX NMEA 2.0 protocol.
- G-Micro sentences forwarding to user port/bluetooth
- Added password for GPS last fix set to currently selected TP location
- Implemented protocol for setting whole declaration from android devices (Set TP, Zones, Glider, Pilot).
- Added NMEA sentences for settings task parameters (AAT time, finish alt), Mc, bal, bugs etc.
- Say avg. vario in thermal (once every turn)
- Added navbox circling radius
- Added navbox effective thermal avg
- Implemented sending task declaration to Flarm device on edit task in menu, received over BT or user port and import from SD

10.15 Version 1.0.10 (2019-03-08)

- Updated fonts.
- Navbox select shortcut added in setup menu.
- Navbox icon colour same as text colour.

10.16 Version 1.0.04 (2019-01-25)

- Added progress bar for map loading.
- Unified look of red cross for invalid data.
- General code improvements.
- Steering refresh rate improved.
- Added confirmation when deleting task.
- Added white on black colour palette.
- Restarting task if start conditions are met again while on first leg.
- Added battery and OAT indication.
- Selectable navbox menu added.

10.17 Version 0.5 (2018-11-14)

- Color palette changed for visibility (from turquoise to green).
- Improvements to airspace warnings.
- General code improvements.
- AHRS page improved.
- General GUI improvement.
- Flarm info added to GPS info page.
- Flarm error popups added.

10.18 Version 0.3 (2018-10-01)

- Ability to turn off APT and TP names added.
- Improved airport icons.
- Airspace manager added.
- General GUI improvements.
- Wifi and Bluetooth dialogs added.
- Improved icons.

10.19 Version 0.2 (2018-09-07)

- General GUI improvements.
- Improved quick setup.
- Added start and finish task turnpoints.
- Added quick next/previous buttons in edit zone.
- Task preview added.
- Active task indication.
- Distances added to navigation pages.
- Competition manager added.
- Waypoint details page added.
- Added themes.
- Logbook details page updated.
- Filtering and sorting airports and turnpoints added.
- Improved text position on maps.

Contact

Headquarters

LX navigation d.o.o.
Tkalska ulica 10
SI-3000 Celje
Slovenia

VAT ID

Company is registered in Slovenia,
EU under the VAT ID: SI40539601

Webpage

www.lxnavigation.com

Phone

+386 (0)3 490 46 70

Fax

+386 (0)3 490 46 71

Sales

sales@lxnavigation.com

Support

info@lxnavigation.com

Type of repair

Regular repair: Warranty repair (please attach the original invoice): Express repair service:

Contact informationDate: _____
Name: _____
Address: _____
Country: _____
Email: _____
Phone: _____**Custom invoice information**Contact: _____
Company: _____
VAT ID: _____
Address: _____**Product information**

1. Product: _____ Serial number: _____ Included with unit: _____
Defect description: _____
2. Product: _____ Serial number: _____ Included with unit: _____
Defect description: _____
3. Product: _____ Serial number: _____ Included with unit: _____
Defect description: _____

Additional notes: _____
_____**Warranty repair form**

Invoice number (Mandatory attaching the copy of original invoice): _____

Terms and conditions

LX navigation reserves the right to apply initial repair fee of 50 eur + vat, which covers the cost of entry inspection, handling, final control, updating, reporting and others. This fee is included in the price of all completed repairs.

The repair system works on principle of »first come, first served«. The unit will be added to an internal repair system and inspected. After inspection the customer will receive the informational email with inspection report and estimated costs of repair.

Please note that for older units there may be no more spare parts available.

The date of finished repair is uncertain, but usually it takes between 1-3 weeks, depending on work load. Some repairs may take longer, due to finding the problem and solution to it.

LX navigation will not proceed with repair unless we get a straight respond on information email sent after inspection of device.

LX navigation is not obligated to keep the device, if the owner does not answer the information email within a 30 day period. If the customer respond after the given period, some additional charges may appear.

Express repair service

LX navigation do offer an express repair service. This obligates LX navigation to send back the repaired unit at least 3 days after receiving it. The costs of Express repair service are double (x2).

I have read and agree with the terms and conditions*:

Fields marked with * are mandatory.

Signature: _____



LX
navigation